

# UNTES<sup>®</sup>

HEATING VENTILATING AIR CONDITIONING

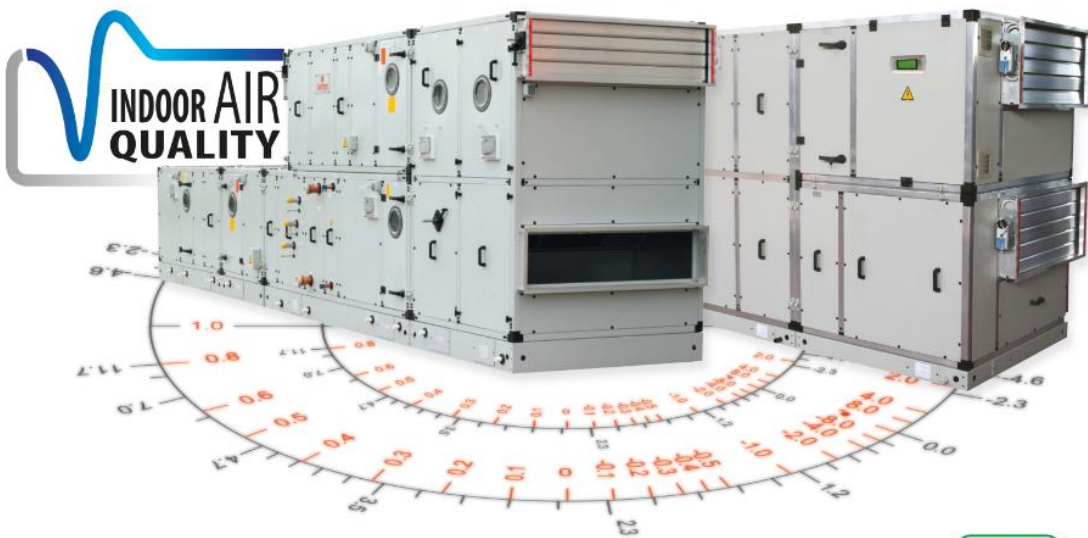

**AIR HANDLING UNIT**  
**ASSEMBLING, START UP, MAINTENANCE and USER**  
**MANUAL**





## **Please read this manual first!**

Dear Customer,

Thank you for choosing UNTES. We hope that the product manufactured in modern facilities and passed through a strict quality control procedure will give you the best results. Therefore, we advise you to read through this manual carefully before using your product and keep it for future reference.

- Please read the Operation Manual before installing and starting your machine
- Particularly follow the instructions related to safety.
- Keep this Operating Manual within easy reach. You may need it in the future.

Sincerely,

UNTES Air Conditioning Systems

## CONTENTS

CONTENTS .....	3
1. GENERAL SPECIFICATIONS .....	5
2. TRANSPORTATION and STORAGE .....	5
3. INSTALLATION .....	6
3.1. Connection of Modules.....	6
4. OTHER CONNECTIONS.....	7
4.1. Duct Connections.....	8
4.2. Pipe Connections .....	8
4.3. Drainage Connection .....	9
4.4. Electrical Connections .....	10
4.4.1. Door Switch Electrical Connections.....	16
4.5. Automatic Controls of Air Handling Unit .....	18
4.5.1. Establishment.....	18
4.5.2. Attentions for Starting-Up and Field Equipments Selection Criteria.....	20
4.5.2.1. Three or two way motorized valves.....	20
4.5.2.2. Valve servomotors .....	20
4.5.2.3. Damper servomotors.....	20
4.5.2.4. Sensors.....	21
4.5.3. Notes and warnings.....	21
4.5.4. Automatic Control Schemas .....	23
4.6. Insertion Of Panel And Bag Filter To The Same Cassette .....	23
5. THE COMPONENTS OF THE AIR HANDLING UNIT .....	28
5.1. Air Dampers.....	28
5.2. Air Filters.....	28
5.3. Coils.....	29
5.4. Plate Type Heat Recovery Unit .....	30
5.5. Rotary Type Heat Recovery Unit .....	30
5.6. Humidifiers.....	31
5.7. Ventilator and Aspirator Fans.....	31
6. SECURITY and WARNINGS .....	32
6.1. Usage of the Unit .....	32
6.2. Warning Sign and Labels.....	32

6.2.1. Earthing Label .....	32
6.2.2. Product Specification's & Warning Labels .....	33
6.3. Training of the Personnel.....	35
6.4. Preventing from General Dangers .....	35
6.5. Recommended Security Applications.....	35
6.6. Unforecasted Dangers.....	35
6.7. Start-Up.....	36
6.7.1. After 2 Weeks of Operation.....	36
6.7.2. Water Spray Type Humidifier .....	37
7. MAINTENANCE.....	37
7.1. General Rules of Air Handling Unit Maintenance .....	37
7.1.1 Once a Month .....	37
7.1.2 Once In Six Months .....	37
7.1.3 Once a Year .....	38
7.1.4 Changing Filters.....	38
7.2. Washing, Cleaning and Disinfection of Hygienic Air Handling Units .....	39
7.2.1. Outfit to Use For Executing Cleaning Operations.....	40
7.2.2. Disposing the Waste Materials Used For Cleaning Operations .....	40
7.2.3. Cleaning Method .....	40
7.2.3.1. Procedure for washing and disinfecting the inside of the operating compartment.....	41
7.2.3.2. Procedure for cleaning the external framework of the air conditioners .....	43
8. BELT TIGHTNESS AND AXIS CONTROL.....	43
9. CHANGE OF THE PULLEYS .....	44
9.1. The Installation of the Pulley.....	44
9.2. Taking Off The Pulley .....	44
10. SERVICE and SPARE PARTS .....	45
11. HOW TO COME OVER THE TROUBLESHOTS .....	45
11.1. How to Find Out the Troubleshoots .....	45
11.2. Table of Finding and Solving Problems .....	45
12. MOTOR INFORMATION .....	49
13. DIMENSIONS OF AIR HANDLING UNIT .....	52
CONTACT INFORMATION FOR SERVICE and SPARE PARTS .....	58

## 1. GENERAL SPECIFICATIONS

Air Handling Units are used in order to find solutions to heating, cooling, humidification, dehumidification, filtration, ventilating and similar demands in buildings. Units are produced with modules those are suitable with the below technical specifications and have suitable standard dimensions.

Class Description	PK-25		PKH-50		Unit
	Class	Value Range	Class	Value Range	
Casing Strength	D1 (M)	$0 < \text{Bending} \leq 4$	D1 (M)	$0 < \text{Bending} \leq 4$	mm / m
Casing Air Leakage (+700 Pa)	L1 (M)	Leakage $\leq 0,22$	L1 (M)	Leakage $\leq 0,22$	lt/sec*m <sup>2</sup>
Casing Air Leakage (-400 Pa)	L1 (M)	Leakage $\leq 0,15$	L1 (M)	Leakage $\leq 0,15$	lt/sec*m <sup>2</sup>
Filter By-Pass Rate	F9	By-Pass $\leq 0,5$	F9	By-Pass $\leq 0,5$	%
Thermal Transmittance	T4	$1,4 < U \leq 2,0$	T3	$1,0 < U \leq 1,4$	W / m <sup>2</sup> °C
Thermal Bridging Factor	TB4	$0,30 \leq K_b < 0,45$	TB3	$0,45 \leq K_b < 0,60$	-

Technical data's according to EN 1886 standards.

Octave Band (Hz)		125	250	500	1000	2000	4000	8000
Sound Absorption $D_E$ (dB)	PK-25	12,6	10,7	12	14,7	14,9	26	31,5
	PKH-50	17,6	23,4	30,4	31,2	29,4	32,3	36,2

Sound Absorption  $D_E$  (dB)

## 2. TRANSPORTATION and STORAGE

- Do not trail along the unit while carrying it to the installation area. Use the carriage and raise up holes under the unit .Do not ever carry it from pipe connections door arms or duct connections.
- Do not put high weight that may cause deflection on the Unit.
- Assure that the damper is closed when the unit is out-offing duty.
- Do not put the unit to the environments where the relative humidity ratio is over 80% and where the environment temperature is less than  $-20^\circ$ , more than  $40^\circ$ .
- Chemical substances and other hazardous gas or burn steams should be kept out of touch with the unit itself and unit equipments.
- The air handling units can be damaged during the carriage especially if a winch is used. In order to carry smaller units it is better to use forklift. The carriage and downloading of the big units should be done by winch. During the carriage and downloading of the unit, in order not to damage it, use appropriate rope according to the weight and dimensions of the unit. As it seen on the picture additional bars must be used not to cause deflection on the frame of equipment. During the carriage, pay attention that nobody stands in the area of carriage.

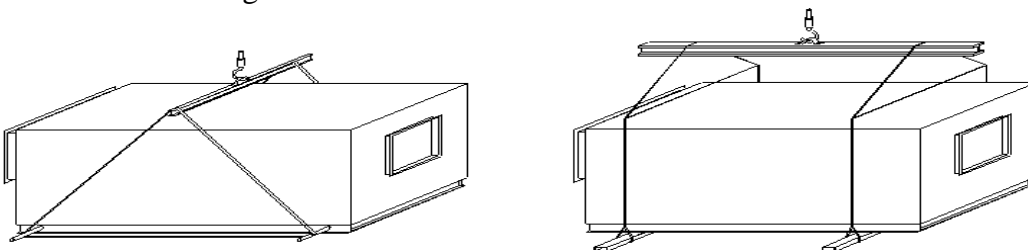

- Before the packing, placement of labels showing the declaration values of the unit and the warning stamps is done. During the loading the carriage and the transportation against the deformation the units

are wrapped with stretch nylon tightly before the packaging and the packaging is done by boxing. The pallets should be larger than the units against the possible damages that can occur.

**NOTE:** Any damage caused by faulty carriage and storing is not under the guarantee scope of UNTES.

### 3. INSTALLATION

Before the production of the unit the client should control where the unit will be put if it is okay with the size of the unit and if the floor is hard enough to carry the unit. There should be enough places around the unit for the service and piping purposes. The base that the unit will put on must be high enough for siphoning (how to calculate siphon height will be explained following sections.). If the unit is to be used at a silence needed place like hospital or hotel, it should be placed on a concrete level where it is filled with styropors as seen on the picture below.

If the air handling unit is established exposed to the ambient air, it must be prevented by coving.

If the units will be hanged to the ceiling, a base must be constructed from steel that must not be damaged by weight of unit and vibration. If it is needed extra support and bars must be used. After the unit is put on the hanged base it must be mounted to the wall from its upper sides. Models UKS 010- UKS 015- UKS 020 may be suitable for hanging. Models, bigger than these models, are not suitable for hanging.

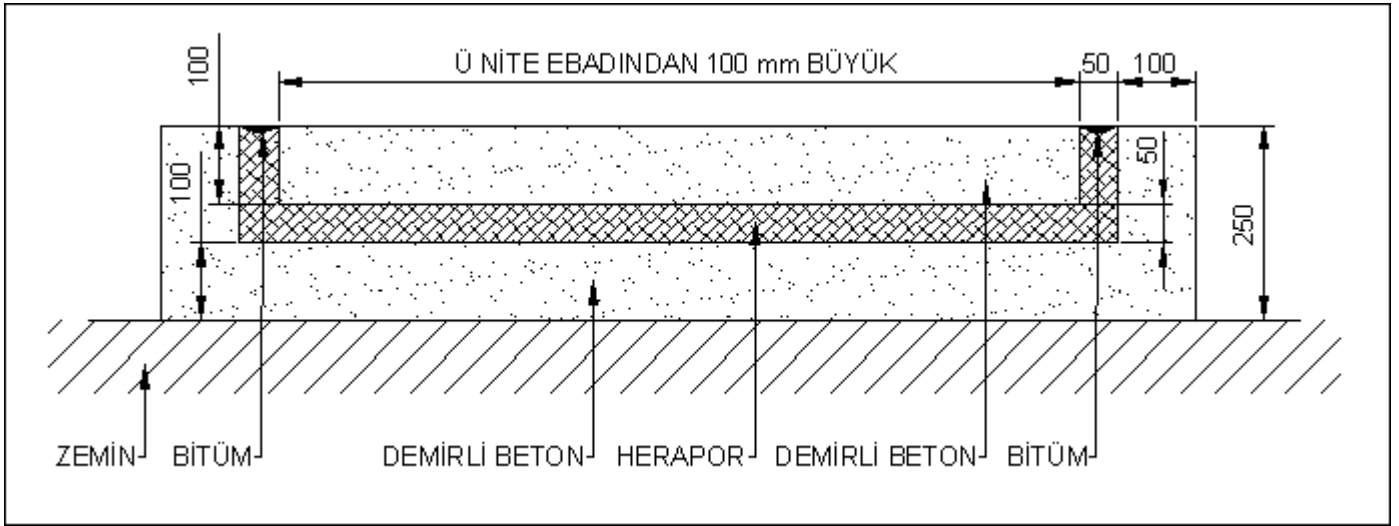

#### 3.1. Connection of Modules

- Control the service direction of the unit and make the connection properly in order of the modules shown at the specs.
- The gasket given by the producer should be pasted on the connection surfaces before the connection.
- Connect the modules with the connection elements given. Avoid screwing the screws to much in order not to harm the panels and gasket. All the screws must be screwed equally. (Connections must be done as it seems in the picture below)

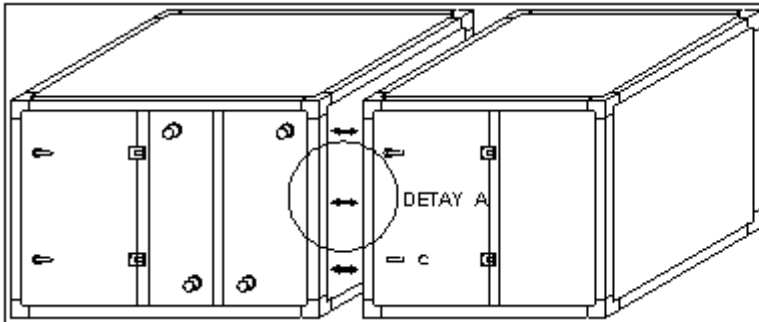

Connection of modules

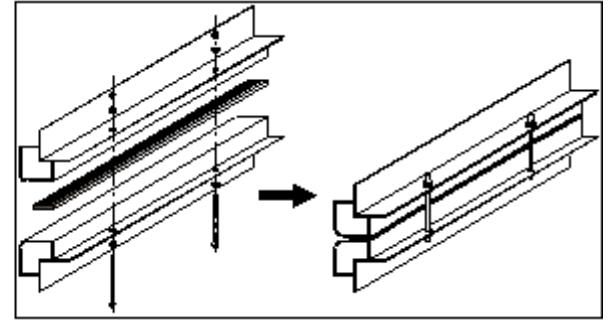

Details (Detail A)

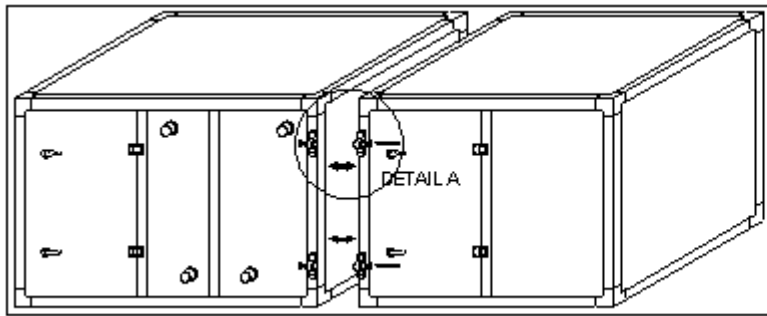

Module connection for Standard unit

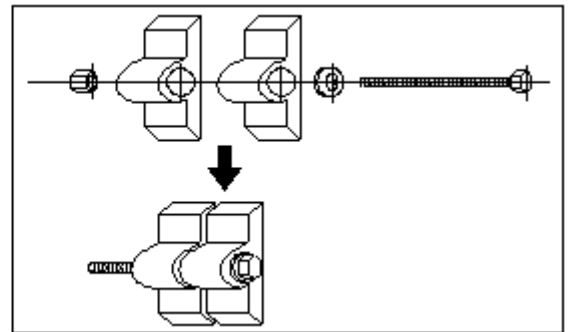

Details (Detail A)

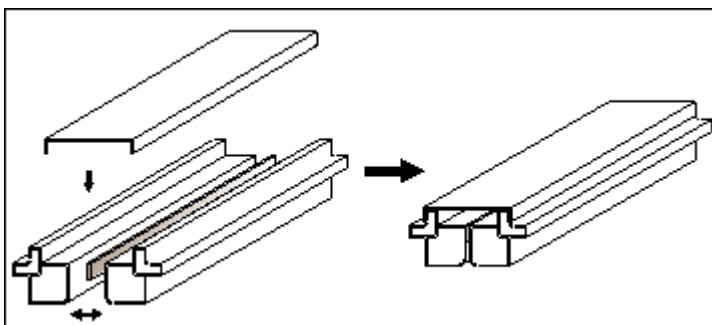

Hygienic units profile connection details

The important considerations for assembling cells and for rain protection insulation applications in air handling units which are operating outside are as follows:

- For the cells which are properly merged, the rain coating is to be examined. It is essential to check whether the coating is damaged or not, whether the surfaces to be bonded are clean and dry and whether the surfaces are at the same plane or not. It is necessary to ensure that the surfaces are clean, dry, collinear and without any tears.
- The sticky protective band over the extra piece which has been left over for the rain covering will be removed and it will be bonded by placing it on the other covering. In order for the bonding to be reliable and lasting, it is appropriate for this procedure to be applied in medium with 20-25 degrees.
- It is essential to press on the bonded surfaces to make sure that there is not any gap lifted between them. In necessary situations, weights should be placed on these areas in order to ensure that they will bond fully and that the bonded surfaces will not flake off.
- In double deck units, extra coating should be installed to cover the surface of upper cell. Furthermore, silicone coating must be applied to other joining nodes where coating is not present.

**Attention! Protect coating from piercer, caustic and corrosive materials and destructive impacts.**





## 4. OTHER CONNECTIONS

### 4.1. Duct Connections

- At the connection points of the ducts it should be used gasket in order to prevent air leakage. And the impermeability should be provided by towing two ducts to each other with clips.
- All air connections should be connected to the unit with flexible joints. Not using flexible joint may cause vibration on ducts and the places that the ducts are connected.
- The wrong connections and installation made can change the air flow conditions.

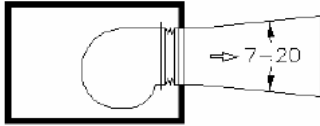

If the supply air has no duct connection makes the connection according to the shape given below .Because this type of connection provides the air to have less turbulence before the air is sucked out. This is more important at the applications of grill and distributor where the pressure losses are calculated according to laminar flow.

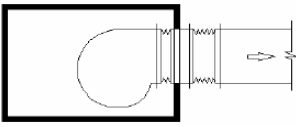

The ducts should be connected to fan exit mouth with a flexible connection component. And it should stay at a tight position to provide sound and vibration isolation.

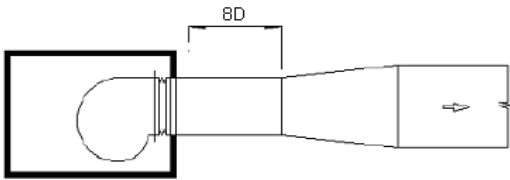

If the flow is in a duct section that is larger than the fan exit at the exit of the fan , before the enlarging part there should be a parallel connection of 8 times of The axis of the fan and with a degree of 7-20°.

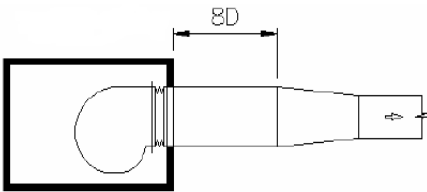

If the flow is in a duct section that is smaller than the fan exit at the exit of the fan , before the narrowing part there should be a parallel connection of 8 times of the axis of the fan and with a degree of at most 45°.

### 4.2. Pipe Connections

- While connecting the heating and cooling inlet-outlet pipes, pay attention to pipes and fittings so that filter unit or panels must not have difficulty to come out. Also between pipe lines and connection mouths, connection pieces with flange should be putted
- For heating and cooling connection lines, ventil for air discharge and drainage valves should be used.
- All installed pipes external to the unit should be supported by appropriate supports in order not to put the weight on coil connection pipes.

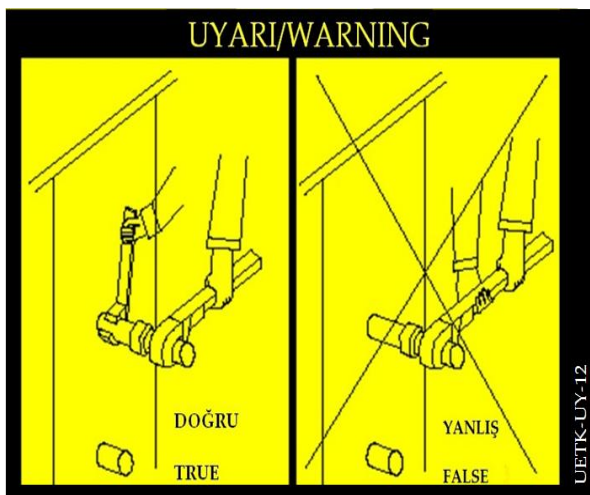

- As a standard, the inlet of heating and cooling is from bottom outlet is from top. The pipe installation should be made according to.
- While doing the pipe connection it is advised to use double wrench. Other case may cause unwanted turn of coil copper connections, causing break or decrease in cross section of connection copper pipes.
- By-pass should be made in order to provide circulation and prevent any freezing risk for the time that tree way valve is not working.



- All connection and installation pipes should be isolated.
- The pipes should be adjusted so that system can continue to work from By-pass in case of heating or cooling coil is to be changed.
- For the units working with more than 60% fresh air, install a circulation pump at pre-heating cell
- Do not operate the ventilator before activating the heat pump at any circumstance. This way you can prevent from freezing-risk.
- In order to avoid the transition of vibration combine inlet-outlet of humidifier pump cell connecting mouths with flexible material.

**WARNING:** You should isolate the duct surfaces and water pipes not to reduce the efficiency of air handling unit.

### 4.3. Drainage Connection

- The drainage pipe diameter should not be smaller than condensing plate exit pipe diameter.
- To clean the sediment that is formed in the condensing plate and in the pipes, the connections should be demountable easily and the drainage pipe and condensing plate connection should be made by sleeve or flange.
- It should be connected to U shaped pipe and filled with water in order not to cause air suction or, for the positive pressure side, to come out of the unit.
- A slope not less than 1/50 should be given to drainage line
- Each drain outlet on the unit must be drained (with siphon) separately. It is advised to use open channel, instead of closed pipe to collect the drains. This is important especially hygienic units to prevent the unit from entrance of unwanted sewage.

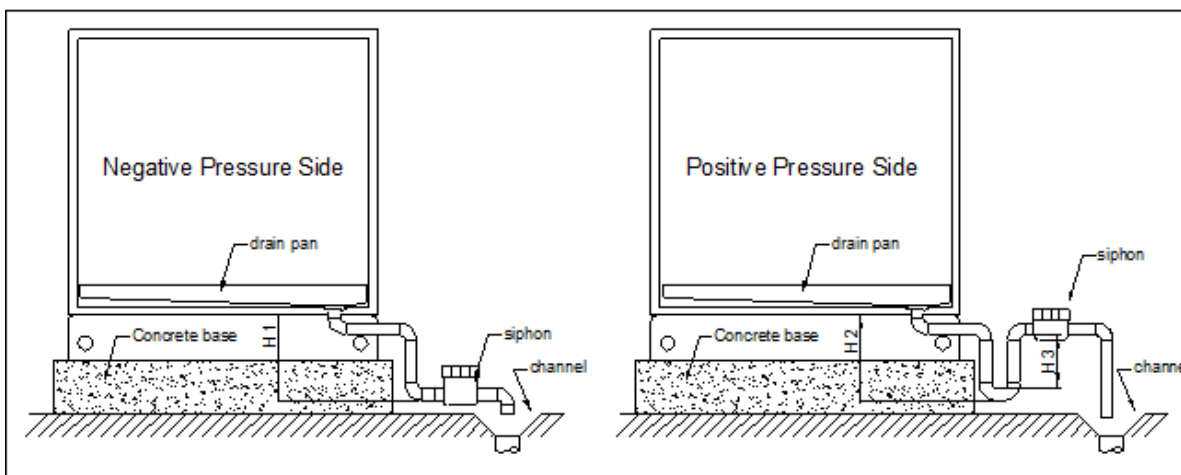

H1-H2 is the height of the total siphon. Total of concrete base that is build by the customer and the metal case produced by the UNTES that is 110 or 200 mm height, connected with the unit. H3 is the siphon height. H1-H2-H3 is a function of the static pressure (P) in mm water gage that the unit has in the cell that includes drain pan. It must be asked from UNTES for each unit.

$$H1 = P + 50 \text{ (mm)}$$

$$H2 = 1.5 \times P + 50 \text{ (mm)}$$

$$H3 = 1.5 \times P$$

If a unit has positive pressure side and negative pressure side siphon together, for the base height, positive pressure side calculations must be used.

## 4.4. Electrical Connections

- All electrical connections should be designed according to the national standards and EN 60204
- The unit must be earthed well.
- All *switch equipment*, cables and all other connection equipments used should be chosen and designed appropriate with the properties of the unit.
- Other than the switch on the electrical board, near the air handling unit an emergency stop switch and maintenance switch must be put according to unit electrical properties and scheme given in the instruction guide.
- At normal applications used in one speed motors directly connected. 5.5 kW and over motors star-delta connection should be done.
- The electrical connections should be made by specialists and it should be made according to electrical diagrams given in the instruction guide and drawings supplied by the manufacturer, properly. For connection problems not proper with the electrical diagram, the unit would be accepted as out of warranty.
- Thermo relay adjustments should be made as following:
  - Direct start: Thermo relay should be arranged according to the current rate defined on the motor label.
  - Star-Delta start: Thermo relay should be arranged according to the 58 % current defined on the motor label.
- Motor Clemens labels are made according to international standards. The phases are labelled as U.V.W and earth.
- Voltage value given at the label should be checked with the main supply.
- Connection details are shown at the electrical diagram which is found stucked on the connection box or in the user guide.
- The standards make it necessary to earthing all the motors properly. For this reason an earth terminal is found inside the electric panel or terminal box.
- In order to prevent the motors to over work and to work in two phases, the motors should be protected by electric circuits or magnetic breaker.
- If the motor needed to be changed for a reason, it must be change with a new motor which has the same characteristics and it must be CE marked. Otherwise it won't be in the responsibility area of ÜNTES Company.
- Electrical equipment that will be used for Air handling unit (thermo relay, switches, wires etc.) must be CE marked.
- The characteristics of motor are given at the end of the guide. The selection of motor is done according to formulation given below.

$$N = (V \times P_T) / (3600 \times 102 \times \eta);$$

N= Power (kW), V= Air Flow (m<sup>3</sup>/h), P<sub>T</sub>= Total Pressure Loss (mm wg),  
=ηTotal Fan Efficiency (0,55 – 0,70)













## 4.4.1. Door Switch Electrical Connections

Door switch is a standard accessory for all models of air handling units and cabinet aspirators. If the electrical connections given below have been done, when the door is opened, motor is closed automatically.

**When the fan door is opened, stopping the free rotation of fan can take a few minutes. In this period touching to the fan can cause serious injuries.**

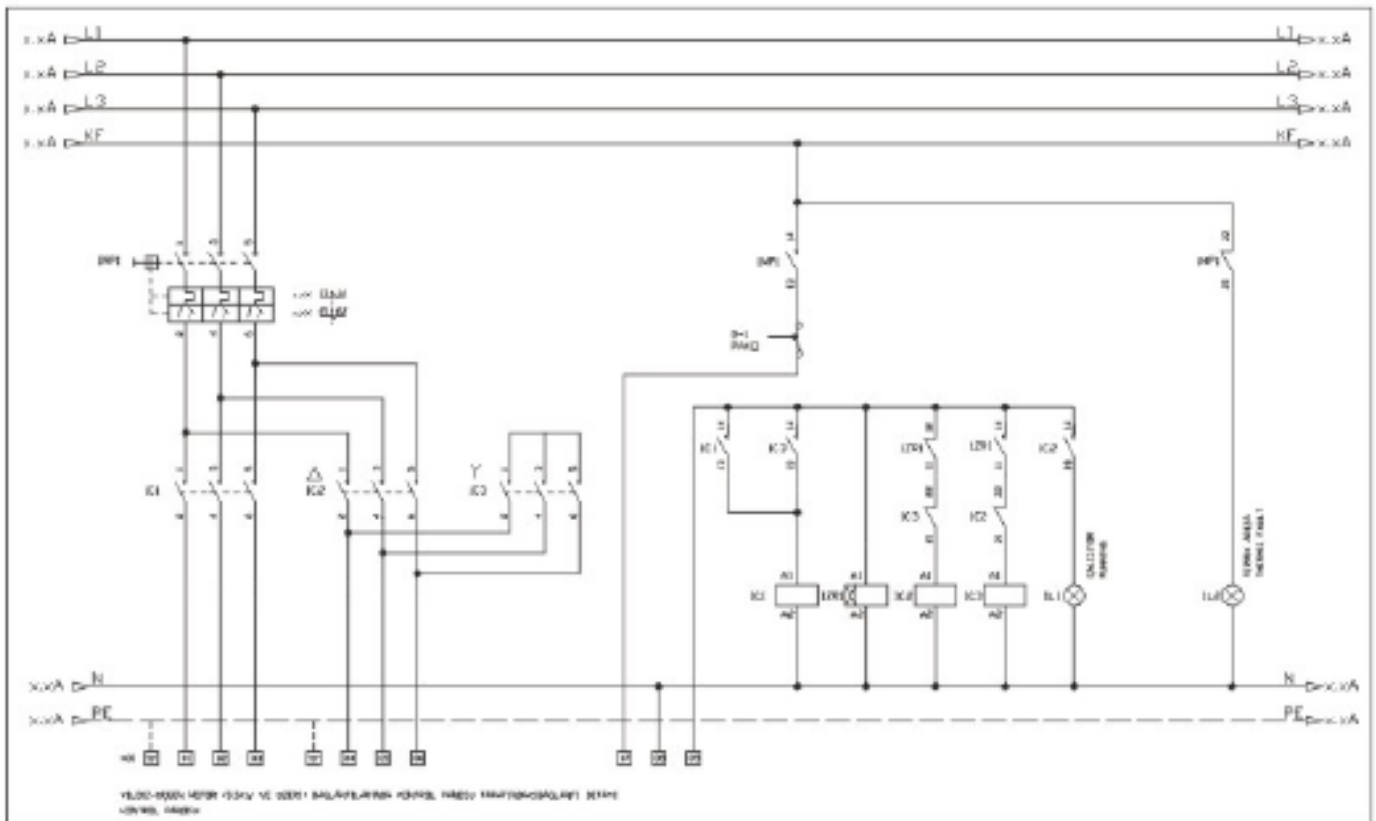

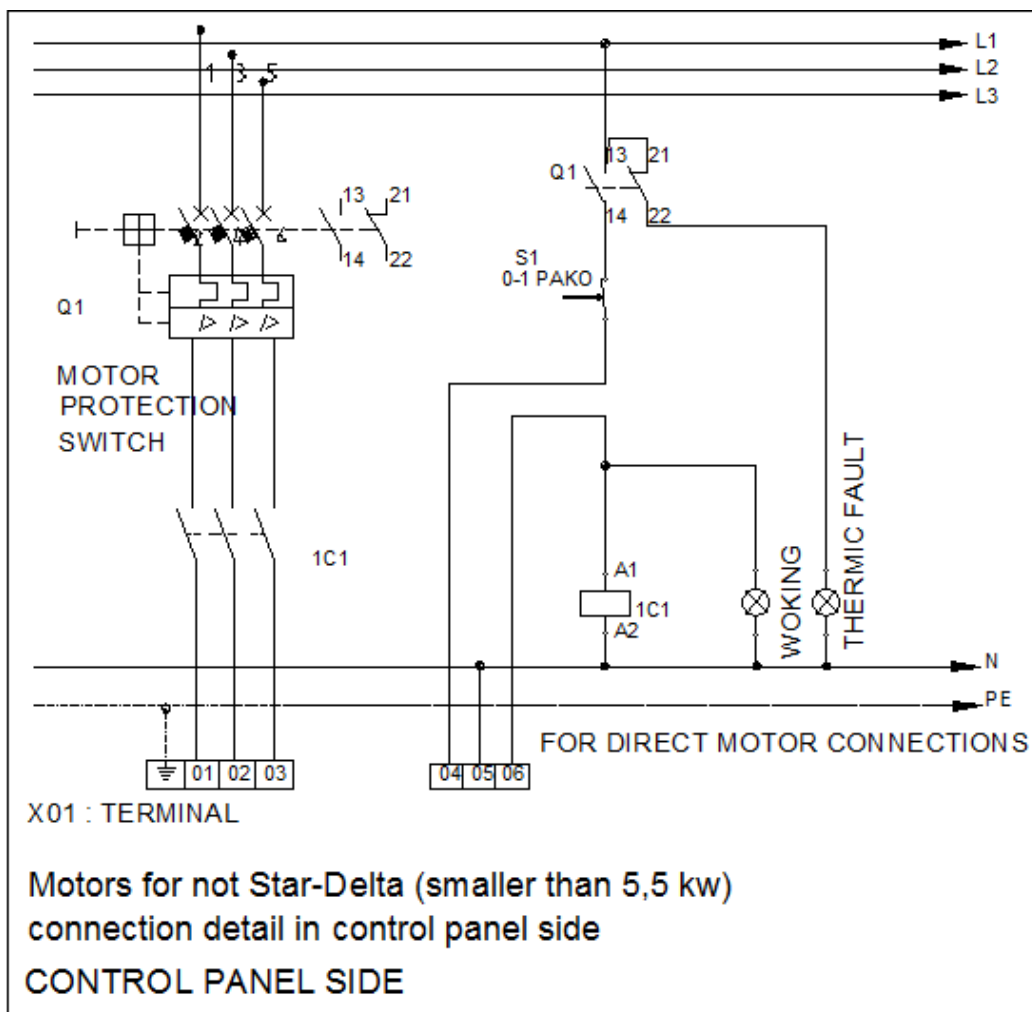
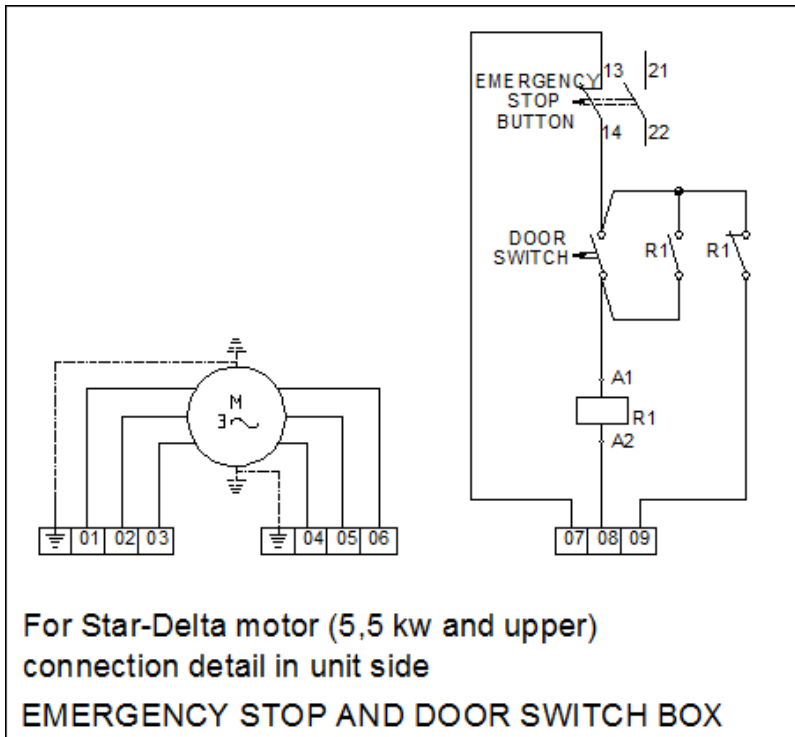

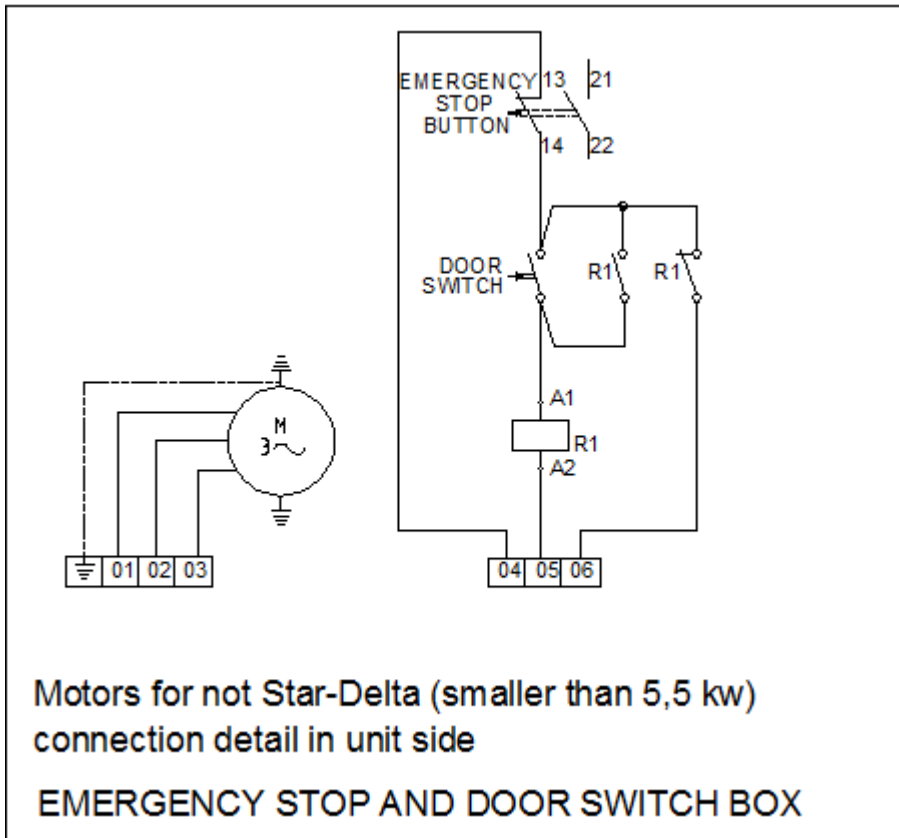

## 4.5. Automatic Controls of Air Handling Unit

The main purpose of establishing an automatic control system on an air handling unit is to get some economy from usage of energy. Another subject is to prevent the unit against the ambient effects. Also it has another benefit that is to achieve some easiness for operating of air handling unit.

Some information is given below about automatic control systems. Writings will include establishment of the system, start up, operating instructions and also some clues and warnings for the system.

### 4.5.1. Establishment

- Firstly System control scenario must be determined. While the control scenario is being determined System requirements must be known. It must be determined that which sections (Aspirator, mixed section, row filter, heating, cooling, humidifying, carbon filter, bag filter, rigid filter, silencer, heat recovery system etc...) AHU have.
- Control points must be determined. Determination of Control points may be done according to the subjects written below;
  - ✓ Analogue inputs ( AI ) should be determined
    - Temperature sensor inputs
    - Humidity sensor inputs
    - Pressure sensor inputs
    - Velocity sensor inputs
    - Air quality sensor inputs
  - ✓ Digital inputs ( DI ) should be determined
    - Aspirator and ventilator operating condition input
      - Thermal protection input
      - Electric motor protection input

- Fan stopped input
- Frequency inverter condition input
- Filter dirtiness condition input
- Freeze warning input
- Steam humidifier condition input
- Temperature thermostat input
- ✓ Analogue outputs ( AO ) should be determined
  - Air damper servomotor control outputs
  - Heating and cooling coil motorized valve control outputs
  - Steam humidifier control outputs
  - Aspirator an ventilator Frequency inverter control outputs
- ✓ Digital outputs ( DO ) should be determined
  - Air damper servomotor control outputs
  - Steam humidifier control outputs
  - Aspirator an ventilator Frequency inverter control outputs
  - Filter dirtiness warning output
  - Freeze warning output
  - Thermal protection output
  - Electric motor protection output
  - Electrical heater control output ( if any )

*Note: Above some of the input and outputs are given. Number of the input and outputs may be increased with the system requirements.*

- Selection of Suitable control panel or panels
- After the selection of control points given above, panels in suitable number and criteria must be selected. The selection criteria's must depend on the selected mark and model.
- Selection of suitable field equipments
- After the selection of panels given above, field equipments (motorized tree way or two way valves, air damper servomotors, in suitable number and criteria must be selected. The selection criteria's must depend on the selected mark and model.
- After selection of equipments, system flow diagram must be prepared and given to the appliers.
- Also Electrical diagrams must be prepared by experienced peoples and given to the appliers

## 4.5.2. Attentions for Starting-Up and Field Equipments Selection Criteria

### 4.5.2.1. Three or two way motorized valves

The criteria's that must be evaluated for the selection of three or two way motorized valves that are used for control of heating or cooling fluid in the air handling units are given below ;

- Type of fluid
- Type of the fluid used in the cooling or heating system and its working temperature must be determined.
- In the air conditioning systems, to get good results from control valves, the selected valve should fulfill the system requirements. For this purpose system and valve characteristics must be evaluated.
- According to application it must be decided that two or three way valve will be used. Also diameter of the valve must be selected
- The diameter of the valve is a function of fluid characteristics.
- It will be selected from producer catalogues.
- Two way valves are used for systems that has velocity controlled pumps to decrease or increase the amount of fluid to control the capacity. To use the tree way valves fluid amount of the system must not change. It does not decrease the fluid rate but it changes the way that the fluid go. Two way valves also are used for heating systems that use steam as heating fluid.

### 4.5.2.2. Valve servomotors

The criteria's that must be evaluated for the selection of valve servomotors are given below;

- For the selection of valve servomotors advices of valve producer should be obeyed.
- For the air handling unit's valve servomotors should be selected as proportional since they are used for temperature control. ON-OFF servomotors may be used only as opening-closing valves.
- For the cases that has high temperature heating fluids is used (like superheated water, or steam), Valve servomotors must have spring return to protect electric motors, filters, cable etc.. From the effects of high temperature. It protects this equipment by closing the fluid when the unit stops for any reason.

### 4.5.2.3. Damper servomotors

The criteria's that must be evaluated for the selection of damper servomotors are given below;

- For the selection of damper servomotors, it is important whether the unit is a fresh air unit or mixed air unit. Otherwise the system needs different, Air damper servomotors may be selected as ON-OFF for fresh air units. If the system design needs fresh air rate control using damper, then proportional damper servomotors may be used. In the mixed air units, exhaust air damper and mix air damper work together. They are connected to each other with a mechanism and controlled with a servomotor. Fresh air damper controlled another servomotor but synchronized to the other damper. These servomotors are used as proportional. Since they control the fresh air rate according to the indoor temperature (of course they are limited with the minimum fresh air rate.)
- Damper servomotors must be selected according to cross section area of damper and static pressure on it. For the comfort systems, since the static pressure change is not so big, Damper servomotors may be selected according to cross section area of the damper only. If the catalogue of the producer does not say otherwise you may use the criteria's given below ;

$0 < A_{\text{dam}} < 1.0 \text{ m}^2$	5 N.m
$1.0 < A_{\text{dam}} < 1.6 \text{ m}^2$	8 N.m
$1.6 < A_{\text{dam}} < 3.0 \text{ m}^2$	15 N.m
$3.0 < A_{\text{dam}} < 6.0 \text{ m}^2$	30 N.m

- Damper servomotor must be selected spring return type. Since they must close the damper even the case of electric cut.

#### 4.5.2.4. Sensors

The criteria's that must be evaluated for the selection of sensors are given below;

- Before the selection of sensors lower and upper limits of the system must be analyzed. After that analyze selection must be done according to the results.
- Sensor can be named according to the place that they are used.
  - Room type sensors
    - These sensors are used in the room directly. They can be used for measurement of temperature, humidity, pressure, indoor air quality etc...
  - Duct type sensors
    - These types of sensors are connected to the Return or supply ducts. They can be used for measurement of temperature, humidity, pressure, indoor air quality etc...
  - Ambient air sensors
    - These types of sensors are used in the ambient air. They can be used for measurement of temperature, humidity, pressure, indoor air quality etc...
- While selecting a sensor it must be considered that the sensor must be suitable with the other components. If it is possible it should be selected as the same mark with other components.
- While the selecting the points where the sensors are put, it must be controlled that the sensor must not be influenced from the other affect different from the effect that is aimed to be sensed.

#### 4.5.3. Notes and warnings

- If it is possible controls should be done from the room means sensors should be in the room. If the system is not suitable for a control from the room, or the number of rooms that have different conditions are more than one, Sensors may be placed on the return or supply duct (that is changing according to the control system).
- While the sensors are placed it must be cared that sensors must be placed so that they never be affected from the other effects. And they must be place so that they can reach the correct conditions of the rooms. Some warnings about the placement of sensors are given below.
  - The cable distance between control panel and the sensor, cable type and cross section should be decided according to the advises of producers
  - Sensors must not be placed under sun light.
  - There must not be any equipment that is producing humidity, heat etc...
  - Especially temperature sensors must not be placed just after the humidifying section.
  - If the room sensors are used, they should be placed at a level of standing people
  - If the room sensors are used, they should not be placed away from air conditioned (Non air circulating places).
  - If the room sensors are used, supply air must not be circulating on the sensor directly.
  - If the duct type sensors are used, they should be placed to the duct where the air flow is laminar.
  - If the pressure sensors are used, their sensing ends must be placed in the correct direction according to air flow direction. For example for static pressure readings the sensor end must be perpendicular to the air flow rate or for the total pressure readings it must be parallel and in the counter direction of the air flow direction.
  - If the indoor air quality sensors are used they may be placed in the room (using the rules for the room sensors written above) or they may be placed on the duct just before the unit. If there is any plenum on the duct best place is the plenum for the duct type air quality sensors. If is there any air leakage near the sensor they must be controlled and prevented before placement since they effect the sensor in a bad way.

- The room type indoor air quality sensors must be away from doors and windows and also from the peoples.
- For the ambient air quality sensors, they must be placed away from any chimney or any other source of dirtiness and also rain or sun light.
- For the air handling units Ventilator and aspirator sections must be followed by the automatic control system whether the fan working or not. For this purpose pressure difference sensors are used. If the fan is stops for any reason ( Electric cut, belt break off, Deformation on the fan etc..) the pressure difference between inlet and the outlet of the fan is get to zero and this is sensed by the pressure difference sensor. After sensing this zero difference precautions written below must taken automatically.
  - Break down signal must be given to the operator.
  - All electric that is given to the ventilator and aspirator that are for the same room is cut.
  - **If the fans are stopped all the sections of the unit must be stopped also (like humidifier, electric heater). This is important because the equipment or the system may be damaged.**
  - After the fan is stopped to prevent the unwanted air circulation air dampers also must be closed.

*Even the problem is solved fan must not be worked automatically. It must be done by the operator. For this purpose on the electric board or equipment there must be a manual reset button.*

- After the fan is started “fan started” information must be given to the control system. And this signal should be used for the activation of the other section.
- If there is any speed control on the fans, according to the system that is used for the speed control producer and the project advises must be followed.
- The fluid control of heating or cooling coils is done with the two or three way motorized valves. Valves are getting the controls from temperature sensors depending on control panels. By this method the temperature control of air is achieved. Panels that are controlling the coils are programmed according to the air conditioning system requirements.
- For heating and cooling lower and upper limits must be determined and used in the control system
- For freezing protection of coils, freezing thermostats are used. For this purpose freezing thermostat should be set to 5 °C. Under the 5 °C, Thermostat operates and stops the fan. Furthermore it closes the air dampers and to increase the flow rate in the coil to the maximum it opens the motorized valve completely. And also it gives a signal for freezing to the operator.
- Freezing thermostat must be one way thermostat. Means after the air temperature goes up to 5 °C; it should not reset the system automatically. It should contain a manual reset button. System must be restarted by the operator.
- Filter dirtiness should be followed by the automatic control system. For this purpose a pressure difference sensor is used. It should be used for each filter unit separately. Even Dirtiness of the filter increase the pressure difference also increases. After the upper limit of the filter that is determined before, is achieved, sensor gives a signal to the system.
- For different filter there are different initial an upper limits. To see these limits please look at the filter part of the manual.
- When the filter is get dirty a signal should be given, but the system should not be stopped. (For the hygienic units, if the filter is not changed after the “filter dirty signal” for a second set point system may be stopped).
- For the hygienic units, the set points given on the label stick on the filter unit may be used as set point of pressure difference sensor. Except the sensor, the manometers on the filter unit of hygienic units may be used for following the dirtiness of the filters. And without waiting the filter dirty signal some preparations may be done before the signal.
- In the humidifier section, measurement of the humidity should be done by humidity sensors. Sensors may be placed in the room or on the return duct.
- For the hygienic units supply air humidity must also controlled and it must not get over the 90% value.
- If the unit has electrical heater, all the cables and sensors must be used as non-combustible.



- For the electrical heater beside the temperature control thermostats, safety thermostats also must be used. If the temperature of the air outlet is increases over a limit value system must be stopped and electric of the heater must be cut. System must not be started automatically. It must have a manual reset button.
- In any time of operation of electrical heaters, when the heaters stop fans must not be stopped immediately. They must work for a minute to cool down the heater. This may be done with time counter or a surface temperature controller.

**WARNING:** Except the notes and warnings that are given here, depending on the system and project requirements, project side controllers and producer may give additional information. They are also must analyzed and added to the control system.

#### 4.5.4. Automatic Control Schemas

Schemas are given on the next pages.

#### 4.6. Insertion Of Panel And Bag Filter To The Same Cassette

	<p><b>Step 1:</b> Reach the filter part from the service door</p>			<p><b>Step 2:</b> Place the bag filter first to the cassette, be sure that the</p>
<p>filter lines are 90° to the ground.</p>				
	<p><b>Step 3:</b> After bag filter placement, the panel filter is placed. Be careful about the filter direction.</p>			<p><b>Step 4:</b> Use the pressing parts to fix the filters and be sure that it is fixed and no air leakage.</p>

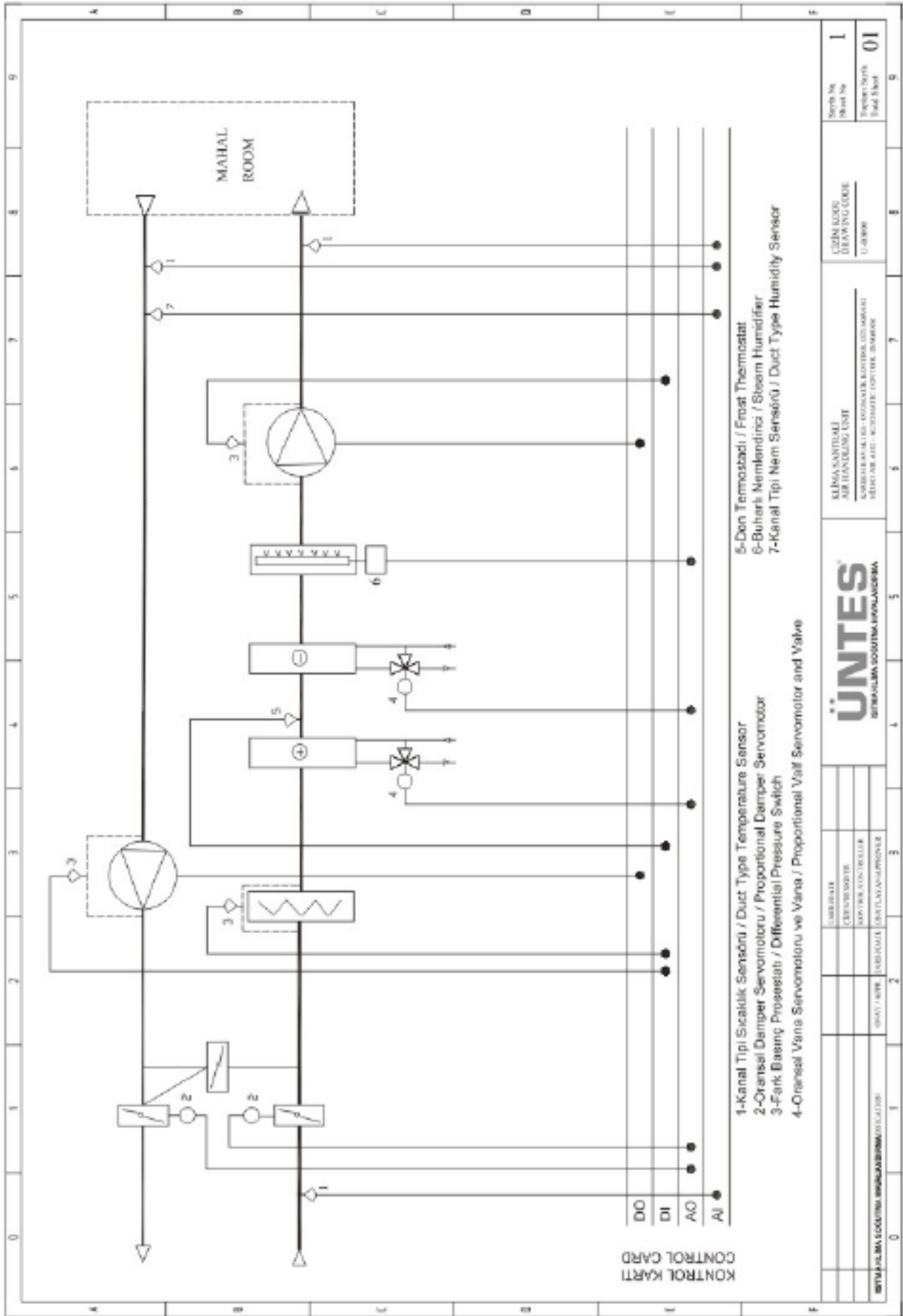

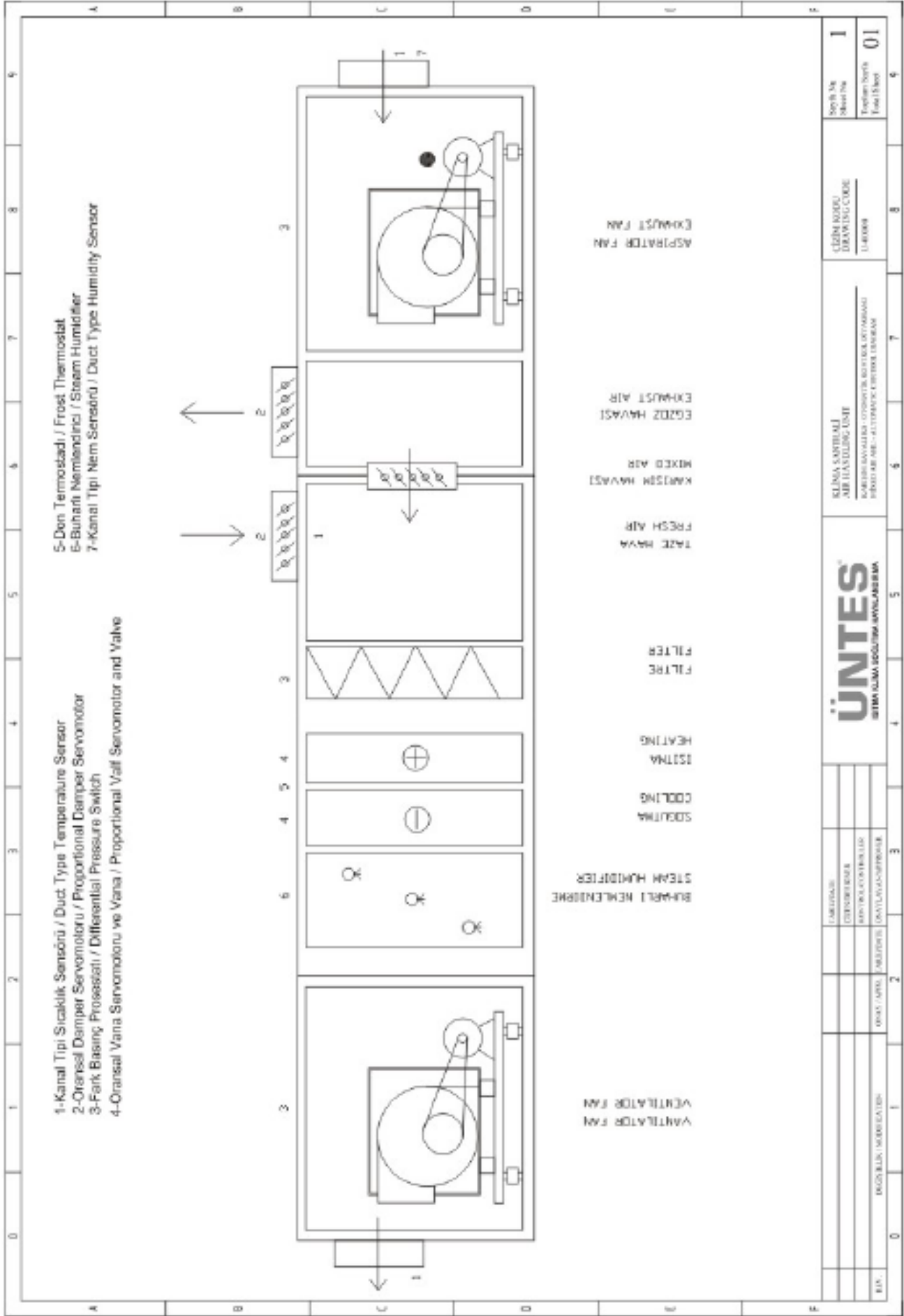

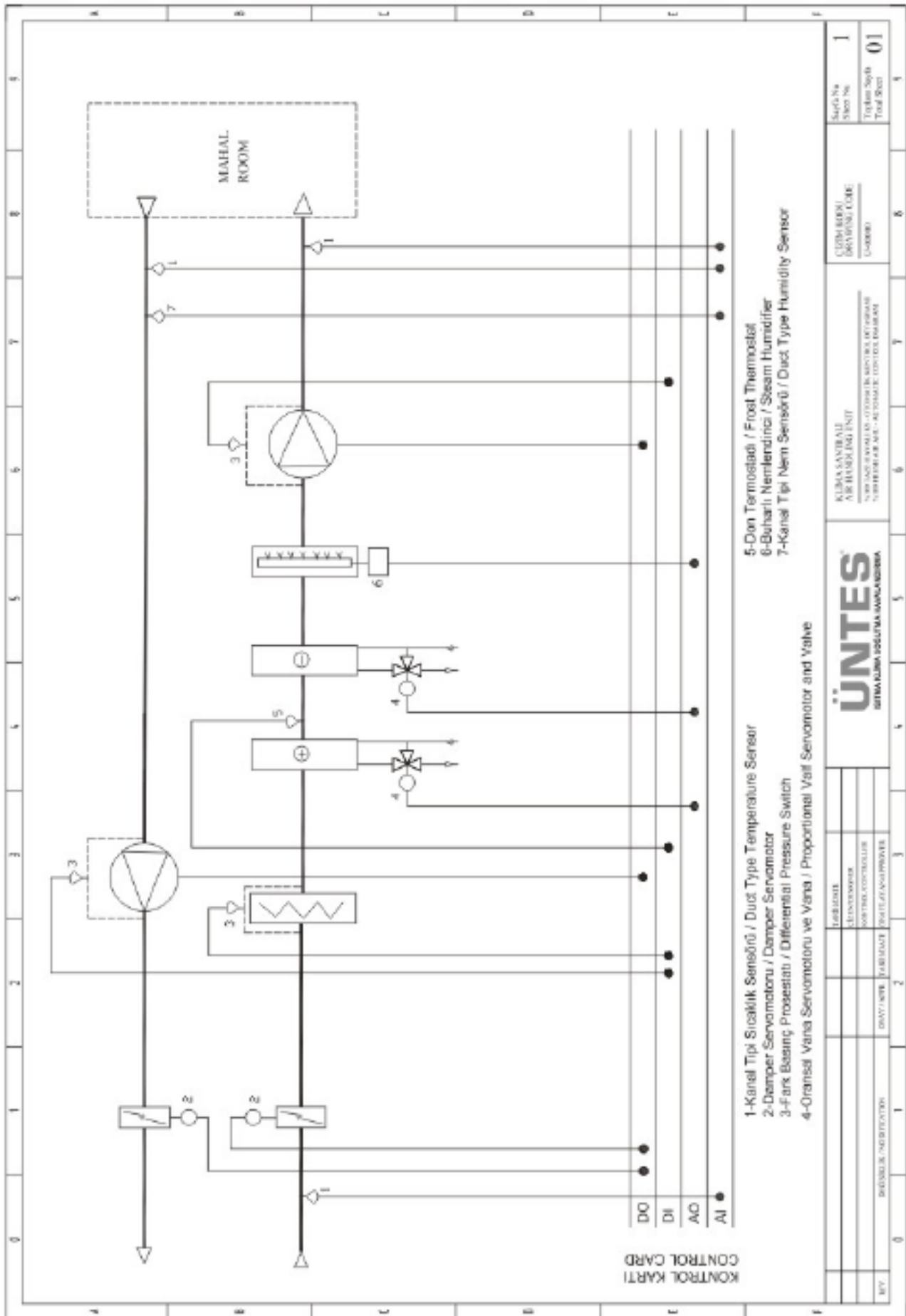

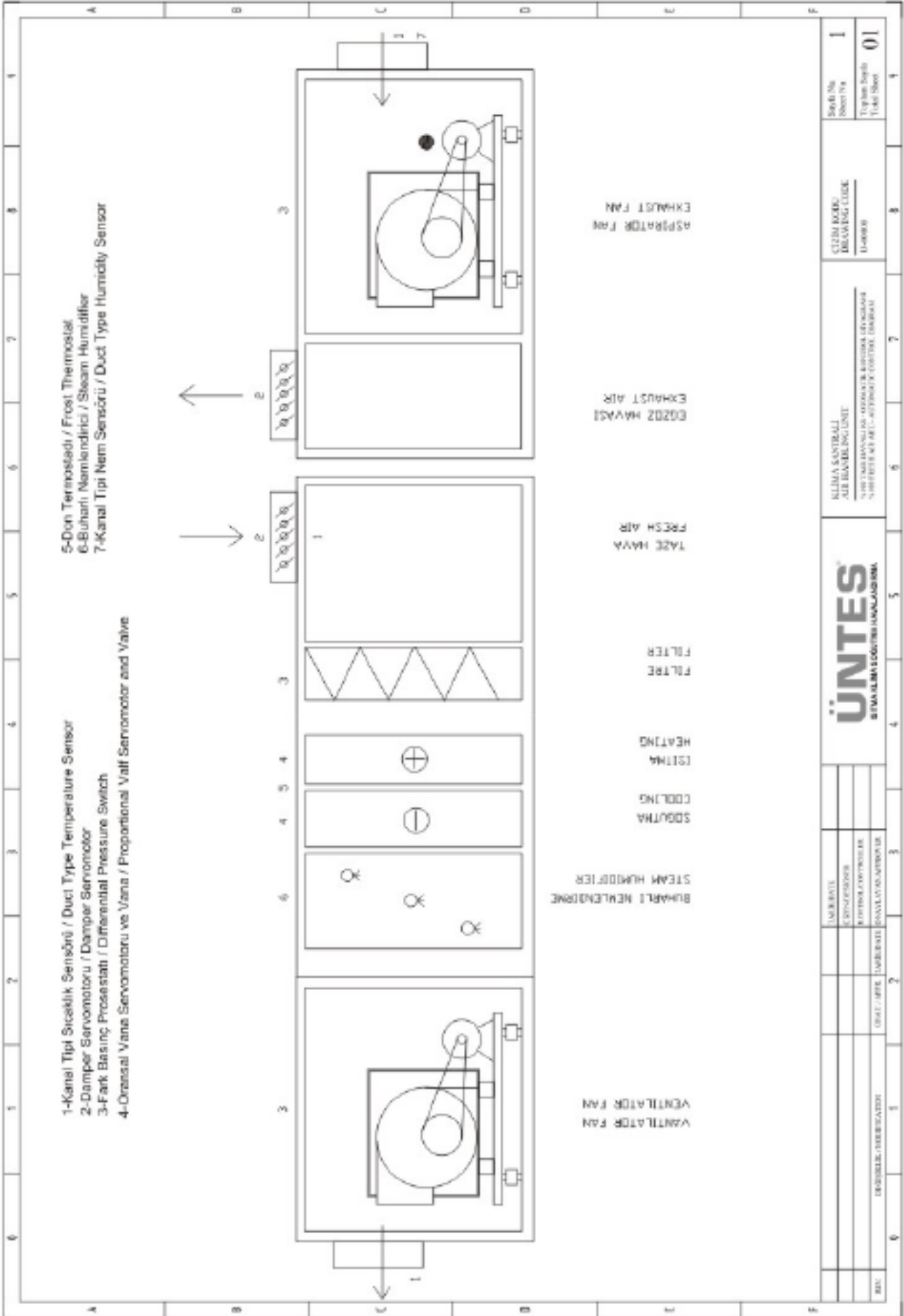

## 5. THE COMPONENTS OF THE AIR HANDLING UNIT

### 5.1. Air Dampers

- Air dampers are controlled by automatic control equipments (servomotor). Controlling the claps at the recirculation cell, do the right arrangements for the operating of the unit and fix the arm. This operation should be done after the ventilator is on and the air-volumes are measured. At recirculation air dampers, the mixing ratio of fresh air and the media is limited up to an interval of the damper. In this case please do not change the settings of the damper.
- If it is needed to operate it manually, please use the damper arm given with the unit.
- The dampers must be turned off while the unit is not working. Especially for fresh air dampers, it causes the item filters to get dirty, reduction in its ability to hold the dust and consequently non qualified acclimatization.
- It is recommended to make an ambient air grill, in front of fresh-air dampers in order to protect it from rain, birds and etc.

### 5.2. Air Filters

- Panel filters and raw filters are fixed on to the unit before the delivery.
- Bag filters are delivered in carton boxes to avoid efficiency reduction and dust accumulation before the start-up operation. Each of the bag-filters should be replaced in a frame that is supported by clips providing impermeability.
- Rigid filters are delivered in carton boxes in an isolated way. During the installation pay attention that the filters are mounted in a safety way without any air-leakage on their frames.
- Other filter, like carbon filters, are given with the units including instruction guides of producers
- The quality level of filters depends on the ability of holding particles in amount and dimension. Inside the ÜNTES units there are pre-filter, bag filter, miniplated (rigid) filter, carbon filter. Depending on the customer needs, the filters can be used separately or in various combinations.
- For the raw filters EU-3 and EU-4;
  1. Open the access door that labelled as filter and Take filter cassettes out.
  2. After cleaning the particles on the unit properly (by air in the direction opposite to the direction of air in the unit), you can wash the filter with warm water. After your filters are dried, you can put the cassette back to the unit.
  3. Do not ever squeeze the filter by bending it and keep it away from high-pressure water. If there is not an automatic system to show the contamination level of filter, it is recommended to make an eye-control on and repeat the cleaning operation described above if it is necessary. After 4-5 washing operation please change the raw filter with the new raw filters
- It is recommended to change the bag filters at every 6-8 months depending on the usage. If you have automatic system that shows the contamination level on the bag filter use the time that it shows. To take off the filter, it is necessary to rescue it from spring clips.
- Change the mini pleated filters or carbon filters at least once a year depending on the usage frequency. If you have automatic system that shows the contamination level on the mini pleated filters, use the time that the system shows. To take off the filters, it is necessary to rescue it from spring clips.
- For all filters after cleaning or changing operation be sure that filters are installed tightly and their gaskets are placed allowing no air by-pass.
- For filters if there is an electronic cont. system, for setting point, uses the max. Pressure difference given in the following pages.

### 5.3. Coils

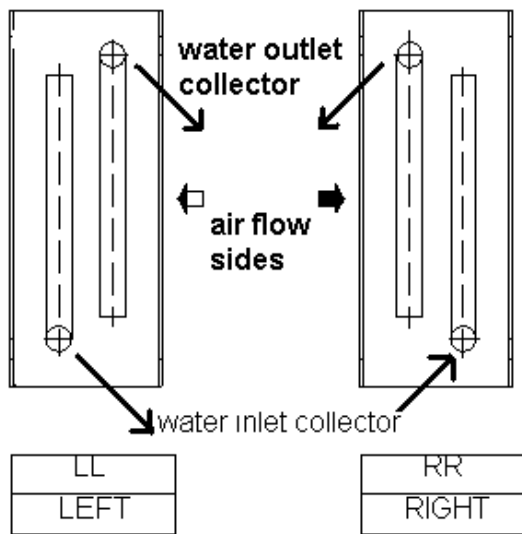

- All coils are controlled and tested against the water leakage. The plates are controlled also against damage. However the plates can be damaged during the delivery, concerning this probability it is better to check them before it is mounted. Unless the unit pipe connections are ready, the plastic covers on the exit of coil-pipes should not be taken off. Take into consider that during the settlement of the unit, piping it and other connecting processes the coil may be moved off if it is necessary.

- In order to provide to air impermeability of AHU a proper rubber cover should be put on the border of the coil entrance and exit holes

- If the fan stops, it is recommended to cut the water flow, at the control system. (On the other hand at the winter conditions to prevent the heating coil from freezing, even though the fan stops water flow must continue.

- Control the inlet-outlet valves of heating and cooling coils according to summer winter situation and turn on heating valve when it is winter, cooling valve when it is summer.
- The water left in the coil must be drained according to the season especially for the cooling coil if it is winter against risk of frozen.
- Check the heating- cooling plates. If the air-filter does not clean up for a long time, dust can be cumulated on between plates of heating or cooling coils. This situation may block the heat transfer, it causes the capacity reduction. If the plates are dirty, clean them with pressured air.
- Since plates are made of aluminium which is a soft material, they may easily bended or crushed. This point should be considered carefully while cleaning the plates.
- -To achieve the air control, the air temperature is requested to be max. 40 °C at suction part of the unit.
- -In order to prevent from freezing the water entering the coil should be min. +2°C.
- -The coil sides in the coils should be totally closed. The air should flow easily touching totally to the coil surface.

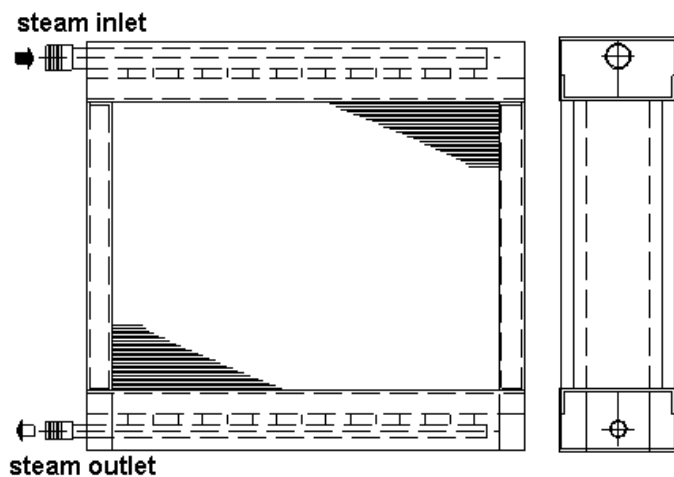

- At vapour batteries entrance should be from top, exit should be from bottom. Because the vapour has been transformed by the phase, the steam condenses and goes out of the battery by the help of collector.

- While mounting the vapour battery into the unit, it should be placed with a suitable slope and any problem that will cause return problem for condense water must be eliminated.

- If the side where the vapour condenses is connected to condense tank with opposite slope and during the stop if the water left on the battery comes across with vapour, “steam impact” occurs. In this

case the condensed steam cannot be thrown away from the system by condense trap. When the unit starts operating again the liquid left at the battery will start a sudden expansion. This sudden pressure increase will go on till the coil pipe damages.

- At steam batteries because of the corrosive effect of vapour and the pressures occurring of expansion, pipes are established as direct as possible.
- At steam batteries high thickness pipes should be used.



## 5.4. Plate Type Heat Recovery Unit

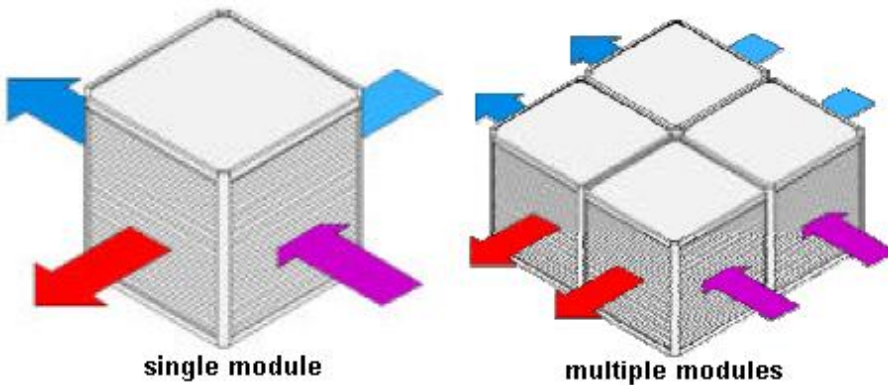

In the heat recovery units which are named as plated, aluminium plates are used which are shaped in a way to create different ways for the exhaust air and fresh air. Fresh air and exhaust air meet on the unit in a way that they can never mix up and there occurs a heat exchange through the plates. Cleaning of this unit is very important because, exhaust air can hold some dusts although it is filtered.

Plate heat exchanger are regularly produced out of 0,15 mm thick seawater resistant aluminium foil. To prevent dirt inside the supply as well as exhaust air should be pre-filtered.

The most common dirt and pollution are dry layers of dust which can be cleaned by using high pressure air. Stronger dirt like wet, greasy and smearing particles have to be cleaned by a high pressure cleaner and steam respectively with hot water. Single block plate heat exchangers can be easily cleaned with a high pressure steam cleaning device. Modular built up plate heat exchangers should be divided in their single blocks and then be cleaned as before. When putting the blocks together again after cleaning please make assure, that the sealing is reinstalled with professional care, otherwise leakages (air and condensate) can occur.

We advise to take a hot water – high pressure cleaning device for cleaning of plate heat exchangers. These units should have following parameters:

Nozzle	: plane jet nozzle
Pressure	: up to 20 bar
Amount of water	: up to 450 l/h
Temperature of warm water	: up to 70° C
Distance to the plate surface	: min. 300 mm
Nozzle direction	: 90° offset to the embossed foil
Cleaning direction	: from extract side to exhaust side

**WARNING:** For very strong resisting dirt you can also use detergent (like biological detergent, washing detergents, etc). In this case you need to clean up finally with fresh water. PLEASE DO NOT USE ALUMINIUM CLEANER! THESE CLEANER CONTAIN ACID AND THEREFORE ARE NOT USABLE FOR THE SURFACE OF OUR PLATE HEAT EXCHANGERS

## 5.5. Rotary Type Heat Recovery Unit



Rotary type heat recovery units are the most efficient heat recovery units in this area. The effective efficiency of the units varies from 50% to 85% depending on usage. Due to usage and installation, a slight unintentional mixture (2-5%) might occur. For the projects in which those mixtures are ignored, those units are preferred thanks to their high efficiency. In addition, with a proper design, this mixture is led away from the fresh air and directed to exhaust air. Rotary type heat recovery units are made of aluminium plates encircled one on the top of another. The plates are shaped in a way to allow airflow when they are one over the other.

It is produced out of between 0,07 and 0,10 mm thick aluminium foil. Because of that, you shall use a high pressure air jet to clean the wheel but the air jet has to be right angles 90° to the wheel surface otherwise, you may damage the thin aluminium foil of the wheel if the air comes at an angle on to the wheel surface.

As a rule this is not normally done because the wheel cleans itself to a high degree because the airflow going thru the wheel is normally fast enough the clean out all the dust and particles. The aluminium is non static so it does not attract any dust due the static electricity due to friction.

## 5.6. Humidifiers

- We can say that the relative humidity below 40% ratio is harmful for human body.
- Dry skin, decrease of human body resistance against infections, the sensation of direness in upper respiration system and difficult respiration problems can be caused by low relative humidity reason.
- In the units between 5 kg/h-90 kg/h capacities, the humidifiers exist in atomizer and steam type.
- At atomizer type; there are water pump (optional), inside filter (optional), centrifugal pump group (optional), valves (optional) and water distribution system. The feeding water coming from the main supply should be connected to the main water supply connection of unit. Overflow and drainage connections must be connected (may be together) to a drainage line according to the rules given above. The connection for pump electric motor should be done and checked according to international standards. The water in the pool should be checked once a month and changed if necessary.

### Cleaning of the pool:

1. Turn off the water inlet.
  2. Turn on the discharge valve.
  3. When the pool is emptied make a good cleaning of the dirt left.
  4. Wash well the pool and the filter.
  5. Turn off the discharge valve. Turn on the water inlet. Fill the pool up to some water comes out from over flow pipe. Check the float. The float is not turned off completely cause's water waste. If the float is out of order change it
  6. Tightly close the observation cover.
- Steam humidifiers produce vapour automatically to make the air reach the necessary relative humidity. Both water inlet and outlet is automatic. The information of the producer firm is given with the unit.
  - The steam distributor pipes will be situated to air-flow with 15°.
  - Also between these pipes and starting point of duct returns there should be at least 2 m.
  - Water used for humidifiers must be clean as to drink. There for water cleaning systems must be used before the humidifiers. Total hardness should be 0-40° (French hardness) and conductivity should be 350-1000 µs.
  - Cleaning of steam humidifier section for hygienic units is mentioned in following sections

## 5.7. Ventilator and Aspirator Fans

- Check if the belt tightness of the ventilator and the aspirator are normal and control the fans by hand (turn them) for friction.
- Check the Hz value from the unit label for unit with plug fan. You need inverter to reach that Hz value.
- Check the air inlet-outlet flex joint and be sure the air leakage does not exist.
- Check the flex joint tightness and be sure that an accordion does not exist.
- Check the fan connections to the sluts and vibration isolators.
- After you start up the ventilator and the aspirator, check the current value on motor label definitively by the ammeter. If the motor holds too much current it may means the air-capacity is more than requested. Make the necessary measurements and arrange the air dampers.

- Cabling should be made responsively with the national standards. Departure form should be made responsively to national standards. (Direct or star/delta connection). The necessary electrical control and protective elements should be provided and mounted. Detailed information's about this subject are given in the "electrical connections" section

## 6. SECURITY and WARNINGS

-Air handling units are produced appropriate with the standards TS 2000, IEC 335-1, EN 60204-1 and according to the conditions of European Community Directives LVD 73/23 EEC, EMC 93/68 and EMC 93/68 and they have CE mark on.

The moving parts inside the unit like fan motor pump etc. and the electrical parts and hot parts (hot water and steam coils, pipes and control elements) are accepted to be dangerous regions. In order to work in these regions the necessary equipment and protection should be used.

### 6.1. Usage of the Unit

Air handling unit are used for heating, cooling and ventilating other air conditioning reasons. Using them for other purposes is considered to be non-rule usage. In such cases the manufacturer would pretend no responsibility.

*NOTE: Standard units cannot be used during the discharge of combustibile and flashing gases. In such applications moveable parts like fan and motor should be chosen exproof.*

- To start-up and installation operations of the unit should be appropriate with the standards of the user's country. It is user's responsibility to obey the laws and the standards. The user should keep away from any behavior that would cause danger.
- It is absolutely forbidden to make a change on the unit either by the user or by the operator. Any damage that reasons from such a change would be considered out of warranty.
- The unit should be run by only authorized personnel with the necessary precautions taken.
- The user or the operator never should take off or turn off the items used for security. If they are put away for maintenance reason, they should be replaced after the maintenance and their function should be checked.
- During any kind of maintenance, the electricity should be cut off.

### 6.2. Warning Sign and Labels

- When the unit is working maintenance and mending is forbidden.
- Opening the door without switching off the power is dangerous.
- Attention! 400 Volt
- Warning label about hot surface

Unit specification and warning labels are like below.

#### 6.2.1. Earthing Label

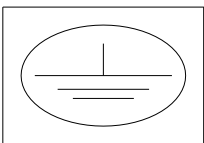

## 6.2.2. Product Specification's & Warning Labels

SICAK SU GİRİŞİ HOT WATER INLET	SICAK SU ÇIKIŞI HOT WATER OUTLET	BESLEME HAVASI ÇIKIŞI SUPPLY AIR OUTLET	<b>DİKKAT! SICAK YÜZEY</b> <b>ATTENTION! HOT SURFACE</b>
DÖNÜŞ HAVASI GİRİŞİ RETURN AIR INLET	EGZOST HAVASI ÇIKIŞI EXHAUST AIR OUTLET	BESLEME SUYU GİRİŞİ FEED WATER SUPPLY	AKIŞKAN SICAKLIK max. 90°C AKIŞKAN BASINCI max. 8 bar
DRENAJ DRAIN OUTLET	SOĞUK SU GİRİŞİ CHILLED WATER INLET	TAŞMA BAĞLANTISI OVERFLOW OUTLET	SULU SPREY NEMLENDİRİCİ WATER SPREY HUMIDIFIER
SOĞUK SU ÇIKIŞI CHILLED WATER OUTLET	TAZE HAVA GİRİŞİ FRESH AIR INLET	ISITMA SERPANTİNİ HEATING COIL	BUHARLI NEMLENDİRİCİ VAPOUR HUMIDIFIER
ASPIRATÖR RETURN FAN	SEPERATÖR ELIMINATOR	BOŞ HÜCRE EMPTY SECTION	KARIŞIM HÜCRESİ MIXING SECTION
VANTİLATÖR SUPPLY FAN	ISI GERİ KAZANIMI HEAT RECOVERY	SOĞUTMA SERPANTİNİ COOLING COIL	SUSTURUCU SILENCER
EMİŞ HÜCRESİ INLET SECTION	FİLTRE FILTER		

 Merkez :53 Cd 1450 Sk N:9/50 Ulusoy Plz Ç. Ambar/ANK  
 Tel : (0312) 287 91 00 Fax : (0312) 284 91 00  
 Fabrika : İstanbul Yolu 37. km. Kazan - ANKARA  
 Tel : (0312) 818 63 00 Fax : (0312) 818 61 50  
 e-mail : untes@untes.com.tr



Proje Adı	
Tip	
Sipariş No	
Hava Debisi	m <sup>3</sup> /h
Toplam Basınç	mmSS
Isıtma Kapasitesi	kcal/h
Soğutma Kapas.	kcal/h
Isıtıcı Akışkan	°C
Soğutucu Akışkan	°C
Elektrik Motoru	
Buh. Nem. Gücü	kg/h
Toplam Elk. Gücü	kW
Max. / Min. TS (Çal. S.)	°C
Cihaz Voltaj / Frekans	
Üretim Yılı / Ağırlık (kg)	

**UYARI!**

Cihazınızda kapı switchi bulunmaktadır. Sensörün aktif olarak çalışabilmesi için pano tarafında yapılması gereken elektrüksel bağlantılar kılavuzda belirtilmiştir. İlgili bağlantılar tamamlandığında, fan kapısı açıldığı zaman motor otomatik olarak kapanacaktır.

**WARNING!**

There is a door switch in your unit. To activate the switch, see the user manual for the electrical connections should be done in panel side. If the electrical connections have been done, when the fan door is opened, motor will get closed automatically.

UETK-UY-4.5

**DİKKAT!**

Fan kapısı açıldığında, motor elektriği otomatik olarak kesilecektir. Fanın serbest dönüşünü tamamlamasını bekleyiniz. Bu süre içerisinde fana müdahale etmek ciddi yaralanmalara neden olabilir. Motor elektriği kesilmezse, kapı switchi bağlantılarını kontrol ediniz.

**ATTENTION!**

When the fan door is opened, motor power will cut off automatically. Wait for stopping the free rotation of fan. In this period touching to the fan can cause serious injuries. If the motor power doesn't cut off, check the door switch connections.

UETK-UY-4.6



**⚠**

**DİKKAT!**  
KAPİYİ AÇMADAN ÖNCE  
FANI DURDURUNUZ.

**ATTENTION!**  
BEFORE OPENING THE  
DOOR, THE FAN MUST BE  
STOPPED.

**ATTENTION!**  
**CONNECT UNIT'S DUCTS WITH  
CANVAS**

**⚠**

**UYARI/WARNING**  
Filtre değişimi ve cihaz  
temizliği sırasında  
kullanım kılavuzunda  
tavsiye edilen kişisel  
koruyucuları kullanınız.

Use personal protective  
equipments mentioned  
in user manual certainly  
during filter change and  
unit cleaning.

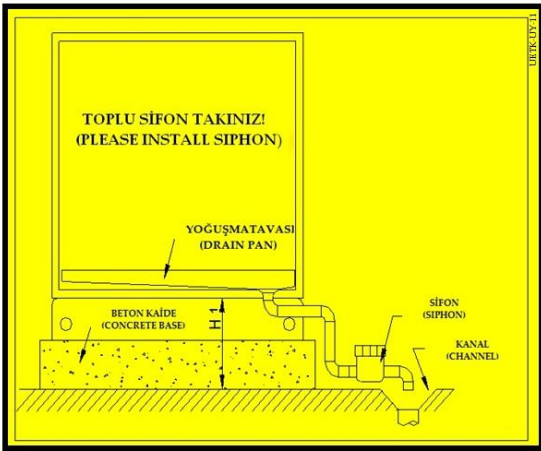

**⚡**

**⚠**

**UYARI/WARNING**

Mutlaka frekans invertörü  
kullanınız ve maks. devre  
uygun frekansı seçiniz.  
Use frequency inverter  
certainly and choose  
appropriate frequency with  
respect to the maximum  
rotation.

Cihaz etiketinde belirtilen  
maksimum devirden yüksek  
devirde çalıştırmayınız.  
Do not turn the fan at higher  
speed than the max. speed  
written on the label.

**⚠**

**UYARI/WARNING**

Cihazı devreye almadan önce montaj,  
devreye alma, bakım ve kullanım  
kılavuzunu okuyunuz.  
Read installation, start up,  
maintenance and user manual  
completely and carefully before  
starting the unit up.

Sistemin montaj ve işletmesini  
ehliyetli personele yaptırınız.  
Make the operation and maintenance  
by authorized personnel.

Cihaz kanal bağlantılarını branda ile  
birleştiriniz.  
Connect ducts with canvas.

Cihazın elektrik bağlantılarını  
kılavuzunda belirtilen şekilde  
kalifiye personele yaptırınız  
ve mutlaka topraklı hat kullanınız.  
Please make machine's electrical  
connections by qualified personnel as  
defined in user manual and use earth  
circuit for electrical connections.

Cihaz beyan gerilimine uygun olarak  
şebeke gerilimini kontrol ediniz.  
Check out the voltage conformity in  
accordance with the voltage  
declaration in instructions.

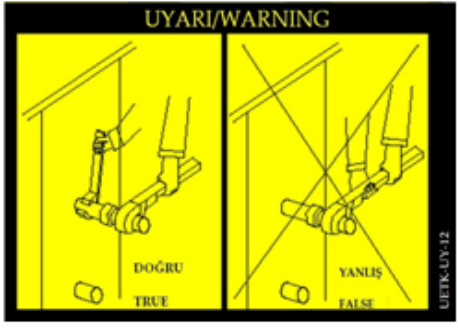

**⚠**

**WARNING**  
Please make machine's  
electrical connections by  
qualified personnel  
as defined in user manual.

**⚠**

**UYARI**  
Cihazın elektrik  
bağlantılarını kılavuzda  
belirtilen şekilde kalifiye  
personele yaptırınız.



### 6.3. Training of the Personnel

Only the educated personnel are authorized to do install, start-up and maintenance activities. These personnel should get help from technical service of production firm or they should have at least 10 years of experience these personnel should be informed of the following dangers by the user or the owner.

- Electrical connections
- Piping
- Duct connections
- Start up
- Maintenance

For the permanence of the warranty the control and maintenance responsibilities should be accepted and obeyed.

### 6.4. Preventing from General Dangers

These units are produced according to the 89/392/EEC directives.

In the air handling units Cells that contains fan and motor are designed with two access door. One is just controlling the fan by eye and can easily be open by hand and the other is to maintenance that is needs tools to open. In this way user are protected from any kind of danger. Also cell contains electrical labels.



- Hot water or vapour coil entrances are labelled with the label that shows hot surface. Also steam humidifier sections have the same label.

### 6.5. Recommended Security Applications

- During the maintenance and repairing activities the technician should cut the main energy supply also the service switch must be closed.
- The entrance of rain and snow inside the unit should be prevented.
- The drainage pipes should be connected directly to the sewer system.
- The damper should be commended automatically.
- In every 3 or 6 mounts the periodical maintenance should be made.
- No water should be formed or enter to the fan sections.

### 6.6. Unforecasted Dangers

- In addition to moving parts, fans ability to suck various materials creates another kind of potential danger. As those materials passing through the fans are ejected out dangerously by the fan, they create a danger. Hard materials can cause damage on fan wings. The protection cages replaced at fan mouths should protect the fan any particles that might enter in so the cages should be chosen with attention. If the protection will be put away, the energy should be cut and locked.
- The doors of the unit and the ducts should not be opened while it is about to stopping or working. The energy should be cut before the entrance of fan section or duct section.
- Opening the door at the positive pressure side of the unit, be careful against the probability of the crash.
- At the suction part of the unit, be careful against the probability of pull.
- In some cases the stroboscopic effects of the light would show the fan as if it is stopped.
- Noise level: Under normal circumstances the noise level arising from air handling unit does not exceed 80 dBA. (Duct connections made and service doors are closed)
- Under forced circumstances depending on acoustic conditions of the room, the noise level might create danger for human health. Earphone should be replaced if it is possible to face with noise more than 85 dBA.

## 6.7. Start-Up

- Assure that all parts of the unit are cleaned well. There may be left remaining of duct isolation or stripes etc.
- Be sure that any kind of protection and security nits are existing with the materials they belong too.
- At the first start-up, to clean up the dust cumulated, demontage all the filters and put on low efficient filters which can be thrown away. After this operation, install the main filters. This way we prevent the filters to get dirty at the first use.
- Check if there are leakages at the pipe connections of the coils. Assure that all of the air at the system of the coil is given out. Check if there is any remain part is left on the coil. Control the inlet-outlet valves of the liquid of the heating and cooling parts; turn on cooling valves if it is summer, heating valves if it is winter.
- Assure that all panels are at their place and all service doors are closed.
- Put some water on the condensing plate and control that it goes into the drainage easily.
- Check the belt of the aspirator and the ventilator if it is tight enough or not and check the rolling and friction with your hand by turning it a few times.
- Check the cloth of the flex joint and tight it. If there is any situation that may cause leakage repair it.
- Check if appropriate phase of electricity line is established and appropriate connection to the motor (star delta or delta-star) is made.
- check the pulleys that are fixed on the shaft and belts are tight enough
- Check if the fan and motor pulleys are moving on the same axis.
- Check the rotation direction of fan by giving energy to the motor for a short time.
- Check the air damper positions and fix them. For this purpose you must turn on the unit and measure the air amount first.
- The most common break-down reason of motors and fans is over air-flow against because of the system pressure losses lower than calculated. In order to solve such a problem, at the beginning main system damper should be closed partially and should be opened when it reaches the right air flow.
- Check if the flexible connections are made properly and if they are without any damage .Assure that the duct connections are made according to the engineering standards and producer's requirements.
- Check the setting of thermal excessive load relay.
- Give electricity and supply the fan to reach the full speed. Check carefully the articles below.
  - Excessive Vibration
  - Extra ordinary noise
  - Competence of belt driven axis.
  - Motor current and voltage values
- Stop the fan after you are sure that there is no problem there is no leakage between the connections and the system is clean. Take low efficient filters out and install raw/bag/Hepa filters. Restart the fan.
- Check the motor current and if it is suitable with the value of the label on the motor.
- Control the in-out temperature of the coils and arrange the water/vapour flow according to this value. Control if control tools are functioning.
- Set the thermostat and check if the heating coil is working.
- Control the pressure at the filters and be sure they are between limits.

### 6.7.1. After 2 Weeks of Operation

After the start-up and working process of 2 weeks the below controls should be made:

- ✓ Belt pulley and belt tightness.
- ✓ The working current of the motor.
- ✓ The temperature of bearings should not exceed 70° just after the stop. If it is needed grease the bearings.
- ✓ Filters contamination level.
- ✓ In order to see the flow make condensation and drainage.
- ✓ Working condition of the automatic control tools.

*NOTICE: Search if there is any change at the fan you can see the problems the probable reasons of these problems “breakdown solutions”. During your periodical observations, keep in touch with Production Company or with other consultants. If excess vibration is observed; stop the fan till the problem is over. As it can cause unbalance and tiring of fan, be careful not to leave any material on the fan. Any change at fan sound level might show that it is necessary to solve a problem. If the motor temperature is high check the cooling fan of the motor. It can be broken or locked. You must also measure entrance current of motors. An increase of the current would indicate serious changes at the temperature of bearings are caused by wrong greasing usually. If you can not understand where the problem arises from, call the experienced personnel.*

### **6.7.2. Water Spray Type Humidifier**

Before starting-up humidifier the below controls should be made.

- ✓ Check if the diffuser and nozzles are clean.
- ✓ Check if pump-motor group turns easily.
- ✓ Check the turning direction of the pump.
- ✓ Check if the water plate is full of water or not.
- ✓ Check if the drop holder is on its place and stays well.
- ✓ Check if the floater valve is operating well or not.
- ✓ Check if there is enough grease at grease box of the water pump.

## **7. MAINTENANCE**

### **7.1. General Rules of Air Handling Unit Maintenance**

A protective maintenance program is an effective part of security program. The maintenance job should be done by expert personnel. Do not try to make any kind of maintenance activity before the electricity is cut and fan security is supplied. In general Standard AHU units (Except hygienic AHU) do not require special cleaning and maintenance activity except the routine one. The maintenance period changes according to working conditions. The main sections that require periodic maintenance are air filters, humidifier pool. The below maintenance program is advised.

#### **7.1.1 Once a Month**

- ✓ Check the belt-pulley devices and the tightness of the belt and make the necessary arrangements.
- ✓ Check the humidifier floaters and spraying nozzles. Check the water flow from the drainage pump.
- ✓ Check the isolation situation of entrance door’s hinges, if necessary grease the hinges.
- ✓ Check the filters and if it is necessary clean or change them.

#### **7.1.2 Once In Six Months**

- ✓ Check the working current of the motor.
- ✓ Check the fan and motor bearings’ temperature and noise level.
- ✓ Check the operation of automatic control equipment.
- ✓ Check the condensing plate U siphon and the drainage line.
- ✓ Check the circulation pump of the humidifier and the motor.
- ✓ Check the humidifier diffuser.
- ✓ Check the warm hot water or vapor pipe system’s condition. Add chemicals if necessary.



## 7.1.3 Once a Year

- ✓ Check the filter frame isolation and change the filter.
- ✓ Check the coils and the wings. If necessary clean with sprayed water.
- ✓ Change the belts
- ✓ Check the motor and fan roller's oil.
- ✓ Check if dampers are working.
- ✓ Check if doors can be opened easily and the lock system is working
- ✓ Check the situation of valves and fittings at piping system.
- ✓ Check all wires, control and isolation items, terminal connections.

*Notice: In case any part is to be changed, refer to the related section of the user guide and make the necessary applications according to working conditions.*

Consult to the relative part of the guide about greasing the rollers.

To take off the coil for maintenance and cleaning purposes apply the below operations when it is necessary.

- ✓ Discharge the water in the coils.
- ✓ Separate the coils from pipes.
- ✓ Take off the side panels.
- ✓ Take off the bolts fixing the coils.
- ✓ Take off the coils.

In order to find other leakages at the coil apply the below operations:

- ✓ Clean the coil surface and the wings.
- ✓ Full the coil with water. (preferred under pressure)
- ✓ Determine the leaking place.
- ✓ Unload the water.
- ✓ Close the crack or the hole determined by welding if it is possible.
- ✓ If the welding is not possible apply to the manufacturer
- ✓ Check if the weld is successful by water again.
- ✓ To install the coil back follow the instructions from reverse

## 7.1.4 Changing Filters

- The maintenance of the filters should be made at the planned time. Dirty filters may decrease the air – flow and consequently the capacity. The maximum pressure differences recommended for different types of filters are shown in the figure as below. If you see these values in manometer the filters should be cleaned or changed these values should not be exceed. Synthetic or metal filters can be washed or cleaned.
- Other filter types like bag or hepa or turn can be changed with new ones. But new filters should be with same dimensions type and efficiency.

Pressure differences for pre-filter

Filter Quality	Initial Pressure Difference	Maximum Pressure Difference Advised
EU-3	40 Pa	140 Pa
EU-4	50 Pa	140 Pa

Bag filters pressure difference

Filter Quality	Initial Pressure Difference	Maximum Pressure Difference Advised
EU-4	65 Pa	150 Pa
EU-5	55 Pa	180 Pa
EU-6	60 Pa	180 Pa
EU-7	115 Pa	200 Pa
EU-9	165 Pa	200 Pa

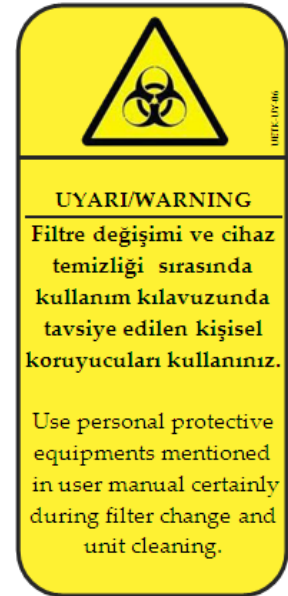

Note: Initial pressure losses may change with the air quantity passing over the filter.

At periodical controls the points below should be controlled also:

The isolation material used in heat and sound isolation

Cable isolation

- Control panel Electrical cables and other electromechanical parts.
- Metal and collared surfaces.
- Connection elements like Screw nuts and washers

## 7.2. Washing, Cleaning and Disinfection of Hygienic Air Handling Units

### WARNINGS

*Before initiating any cleaning operation, it is indispensable to read carefully the following preliminary instruction and fully understand their content. All cleaning operations shall be executed observing such directions, as any improper procedure may cause serious damages to the equipment and/or harm the operator.*

*The air Handling units contain live and pressurized parts. Therefore, to avoid any possible hazard, it is indispensable to execute the following instructions before opening the unit and carrying out any cleaning:*

- *Make sure that the electricity has been disconnected.*
- *Make sure that all live parts (compressor in the driving compartment, return air fan, and supply air fan) have come to a complete stop (that is, have ceased moving).*
- *All the electric feeding circuit of the equipment has been opened.*

*These instructions refer exclusively to the cleaning of the air handling unit. Therefore, we take for granted that maintenance, cleaning, and/or disinfections of the other parts of the plant (inside of the ducts, vents and/or air diffusers, grille for air return from the room, germinal lamps, humidifier feeding water treatment system, condensate discharge system, etc.) have been carried out within the deadlines and following the procedures indicated by the relevant constructors and by the installer that has executed the system.*

*In fact, the execution of the only cleaning, washing and disinfections, even if executed observing the instructions contained in this handbook, is not enough to guarantee the necessary sterilization of the whole system. Even if they are equipped with internal filters, air handling units have been designed to guarantee*

*the environment air-conditioning, not its sterilization. In fact, to obtain the required sterilization in the environment, the installer shall mount, at its care and cost, hepa filters by each vent or diffuser to the room.*

*The cleaning operations relating to the air handling units used for conditioning operating theatres shall be executed by personnel previously and duly trained to this end by the hospital's maintenance service, in order to prevent the air conditioners themselves from being contaminated by proliferations of bacteria. Only in this way, the health of the cleaning operators, medical staff, and of the patients entering in the rooms conditioned by these units in the future will be protected.*

### **7.2.1. Outfit to Use For Executing Cleaning Operations**

Unless otherwise specified by the physician in charge of the surgical room, the personnel entrusted with the cleaning operations should wear the clothes listed below, in order to both protect their health and safeguard the result of the operations they carry out on the unit:

- A clean overall
- Protection goggles
- Latex gloves (during cleaning and disinfections operations on the operating compartment, the gloves shall be replaced as soon as they get dirty).
- Antiseptic half-mask respirator.
- Top footwear

Once the cleaning operations have been terminated, all the clothes used for these activities shall be disposed of as contaminated waste, with the exception of the overall, which may be re-used, after appropriate washing and disinfections.

### **7.2.2. Disposing the Waste Materials Used For Cleaning Operations**

Cleaning these units originates both solid waste (replaced filters, operator clothing, worn-out belts (if any), and sewage (washing fluid and rinsing water residue).

The solid waste shall be put into hermetically sealed containers, and shall be disposed of together with the septic solid waste of the hospital. Conversely, the sewage can be discharged into the drain of the condensate discharge back fitted on the apparatus. These backs shall be previously connected with the septic sewage system of the hospital.

### **7.2.3. Cleaning Method**

As the air conditioners contain electric components (electric motors, terminal boards, feelers, etc.) that cannot bear plenum water jet or high temperature, and a cooling system that cannot undergo high pressure, when executing any cleaning operation, the operators shall not use:

- Any jet of steam
- Any jet of plenum water

The disinfectant and the water necessary for disinfecting and rinsing the apparatuses shall be used only in atomized form, and then be disposed of as septic sewage. You can obtain the atomized solution for cleaning the air conditioners using appropriate manual atomizers.

The cleaning and washing operations shall be executed using only water plus 4% ammonium chloride solution (or a chemically equivalent commercial solution) to atomise with a manual atomiser.

Each air conditioner can be divided into two sections;

**Operating compartments**

Containing the parts in which the air treatment occurs. This area is licked by the outdoor air, which is treated and then supplied to the surgical room, and the air flow coming from the surgical room (for mixed air units).

Despite the filtering system adopted for the air suction, return and distribution systems, and the unit, bacteria may nest in these parts of the air conditioner in the long run, and proliferate during inactivity periods, which would make the later use of the unit unsafe from a hygienic standpoint.

Such compartment shall be washed and disinfected (using the methods specified hereafter) at least once a month, and always in case of surgical operations involving a risk of propagation of harmful bacteria.

Anyway, as the frequency and mode of use of the surgical rooms are various and different, the responsibility of deciding about the need for a washing and disinfections of such compartments pertains exclusively to the Physician in charge of the Ward in question.

**External framework of the unit:**

The external frame work of the unit is made of painted plate, so it only needs to be cleaned according to the criteria and following the specific procedure described in this handbook.

If the unit is installed directly in the surgical room or in any room in which any septic contamination may occur, it should be cleaned whenever the operating compartment are washed and disinfected, or even more frequently, to the sole discretion of the Physician in charge of the Ward in question.

Each section shall be cleaned with a different method, as each method applies to specific areas. Further, the following order shall be observed.

- ✓ Washing and disinfecting the operating compartments
- ✓ Cleaning the external framework of the unit

**7.2.3.1. Procedure for washing and disinfecting the inside of the operating compartment**

The inside of the operating compartment is licked by the outdoor air and by the airflow from the surgical room (for mixed air units). This is why they can be subjected to accumulation and proliferation of pathogenic microorganisms, even if appropriate filters are installed both on the unit and on the air suction and discharge networks.

Therefore, they must be washed and disinfected on a regular basis.

Unless otherwise specified by the Physician in charge of the ward in question, they shall be washed and disinfected:

At least once a month, regardless of the use of the apparatus. Whenever any operation that may give rise to the propagation of pathogenic microorganisms is executed in the surgical room.

Before washing and cleaning the unit, if it is needed coils may be extracted from the unit to increase the efficiency of the washing of them. To extract the coils you need to close the manual valves on the hot water input and output pipes (mounted on the framework of the unit by the installer). So the coils are isolated from the water pipes, the coil can be removed from the frame by unscrewing the screws and sliding it on the special guide. Now coils can be washed and sterilized like all the other parts.

The washing and disinfections procedure is the following:

- Make sure you have all the necessary material and spare filters.

- Stop the unit and disconnect the electricity by turning the main switch and service switch off.
- Put a notice on it saying that the unit is under maintenance.
- Dismount and replace (if necessary) the pre- filter on outdoor air intake. These filters can be disposed of as standard solid waste, as they should not be subject to bacterial contamination.
- (For mixed air units) Dismount and replace the filter on the air return from the surgical room. The dismantled filter shall be put into a hermetically sealed container, and then disposed of following the same procedure as for the septic waste of the hospital. Great care shall be taken in cleaning the room between the air return damper and the filter seat, where dirt is likely to deposit.
- Dismount and replace the hepa filters before the vents and/or air diffusers to the room. The dismantled filters shall be put into hermetically sealed containers, and then disposed of following the same procedure as for the septic waste of the hospital.
- Dismount the filters on the unit (G4 – class filter on the air return, G4 class post-filter on the outdoor air suction, and G7 or G9 –class rigid filter on the air supply). The dismantled filters shall be put into hermetically sealed containers, and then disposed of following the same procedure as for the septic waste of the hospital.
- The spare filters shall be mounted later; as otherwise, they may get damaged during the washing and disinfections.
- Dismount the drops eliminator
- Wash and disinfect operating return-side compartment with a 4% ammonium chloride solution to atomize by means of a hand atomizer in following order, until all the components are completely washed:
  - ✓ (For mixed air units) On the overpressure damper of the air exhaust.
  - ✓ (For mixed air units) On the return air fan, turning the runner by hand until it is completely washed.
  - ✓ (For mixed air units) On the heat recovery coils (if any) on the return airside. The coil shall be sprinkled abundantly with the solution from the top of its upper face until the solution comes out of the bottom side.
  - ✓ (For mixed air units) On all the pipelines running inside the compartment.
  - ✓ (For mixed air units) On the circulation pump of the heat recovery circuit (if provided).
  - ✓ (For mixed air units) On the blades of the return air damper.
  - ✓ (For mixed air units) In the room between damper and filter.
  - ✓ (For mixed air units) On the framework of the return air filter.
  - ✓ (For mixed air units) On the internal walls of the compartment, starting from the top.
  - ✓ (For mixed air units) On the bottom pan.
- Rinse abundantly the internal parts of the return-side operating compartment by atomizing sterilized water with a manual atomizer. The rinsing operation shall be executed following the same sequence described at previous point).
- Wash and disinfect the supply side operating compartment with a 4% ammonium chloride solution to atomize with a hand atomizer in the order specified below, until all components are completely washed:
  - ✓ On the levers and blades of the outdoor air damper.
  - ✓ In the room between damper and filter.
  - ✓ On the framework of the outdoor air filter.
  - ✓ On the heat recovery coil (if present) on the outdoor airside. The coil shall be sprinkled abundantly with the solution from the top of its upper face until the solution comes out of the bottom side.
  - ✓ On all the pipelines running inside the compartment.
  - ✓ On the drain pan beneath the heat recovery coil (if present)
  - ✓ On the assembly consisting of the pre-heating, cooling, and reheat coil (if present). The coil shall be sprinkled abundantly with the solution from the top of its upper face until the solution comes out of the bottom side.
  - ✓ (For mixed air units) On all the blades and levers of the by-pass damper
  - ✓ On the internal walls of the compartment, acting from the top.
  - ✓ On the bottom pan.

- ✓ Rinse abundantly the internal parts of humidifier section of operating compartment by atomizing sterilized water with a hand atomizer.
- Clean and disinfect the supply air fan using access door, turning the runner by hand until it is completely washed. Do not forget to open the tap on the drain of the fan
- Rinse abundantly the internal parts of fan section and fan by atomizing sterilized water with a hand atomizer.
- On the humidification system.
  - ✓ On all the pipelines running inside the compartment.
  - ✓ On the condensate discharge pan.
  - ✓ On the internal walls of the compartment, acting from the top.
  - ✓ On the bottom pan.
  - ✓ Rinse abundantly the internal parts of humidifier section of operating compartment by atomizing sterilized water with a hand atomizer.
  - ✓ Wash and rinse the components of the drops eliminator dismantled beforehand.
- Mount the hot water coils back (if it is extracted).
- Mount the discharge adjusting damper back on the duct following the specific instructions provided by the installer that has laid the system.
- Mount the new filters on the unit.
- Make sure that all the internal parts are completely dry.
- Connect the electricity by turning the main switch and service switch on.

Now the unit is ready to be set at work again.

#### **7.2.3.2. Procedure for cleaning the external framework of the air conditioners**

If the unit is installed inside the surgical room or in a communicating room (anaesthesia room, recovery room, post operation monitoring room, etc.), its external framework shall be cleaned whenever the operating compartments are washed and disinfected, unless otherwise instructed by the physician in charge of the Ward. Conversely, if the unit is installed in a technical room not communicating with the surgical room, it may be cleaned every time the framework presents any trace of dust and/or grease mark.

The framework shall be cleaned as described below:

- Disconnect the electricity by turning the main switch off also close the service switch on the unit.
- Put a notice on the main switch saying that unit is under maintenance.
- Clean the frame work with an alcoholic solution (or with any other chemically equivalent solution) by sprinkling it on the surface, and remove it with a clean cloth wiping firmly. For no reason the framework shall be cleaned with solvents (acetone, benzene, petrol, Trichloroethylene, etc...) or with powers or abrasive creams which might damaged it. After cleaning the cloths used for cleaning the unit must put in to hermetically sealed container and then must be disposed with the waste of the hospital.

After cleaning connect the electricity again by turning the main switch and service switch on.

#### **8. BELT TIGHTNESS AND AXIS CONTROL**

As it is seen on the picture when the belt is stretched, 25 mm (1") resilience should be obtained.

If the resilience is much more than this value it shows that the belt is not tight enough. If it is not fixed it may cause a decrease at the fan speed and attrition because of corrosion.

Low resilience would mean the belt is too stretched and if it is not released it causes short belt life, roller failures, too much vibration and noise.

Efficiency is another reason that the belt resilience should be arranged. Extra stretched belt would cause a normal motor to be over loaded.



Before fixing the motor the pulley axis and the channels on the pulleys should be on the same axis. (Or the pulley surfaces should be on the same line.) For this purpose strait bar, like the one shown in the picture, can be used. If the pulleys are on the same axis, lengthen the belt life and diminishes the noise.

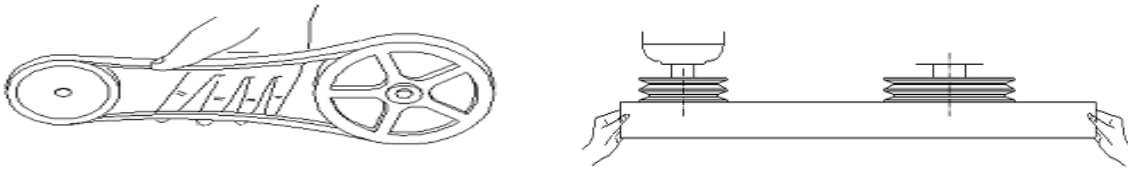

## 9. CHANGE OF THE PULLEYS

### 9.1. The Installation of the Pulley

Clean and grease the grinded surface of shaft, pulley and bushing. Place the screws in relaxed form and put the bushing on shaft by controlling the axis to the half geared hole. Place the bushing on the shaft. Slip the pulley to the position that you want (screws are not screwed). And then, screw the screws for same amount. Never use excessive force on the screws.

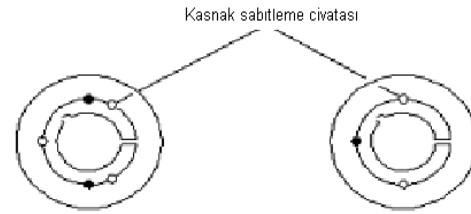
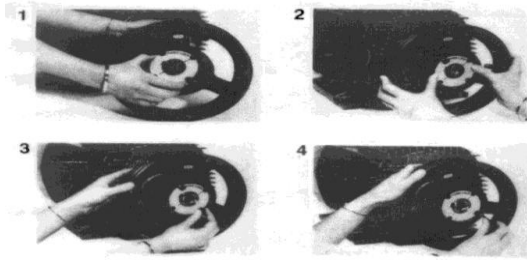

### 9.2. Taking Off The Pulley

- Take off fixing screws.
- Put one of the screws to the third hole and tight it till the bushing on the shaft is relaxed...

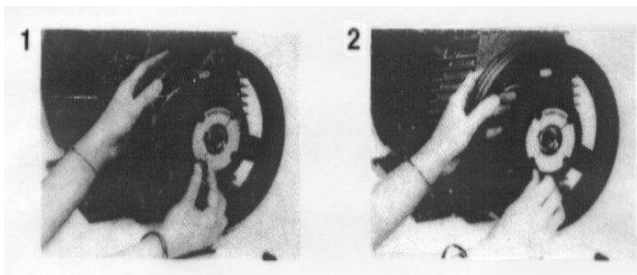

Kasnak sökme delikleri  
(Yarım diş açılmış)

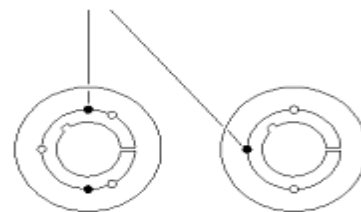

**ATTENTION:** do not use hammer or any force lent to take off the pulley. Do not change the pulleys without permission of the producer's. Otherwise the producer will not be responsible of the conclusions.

## **10. SERVICE and SPARE PARTS**

When technical service is required, our technical service management acknowledges the user about what to do and expertise personnel is charged to check whether the necessary operations have been done or not. If the check result is OK, the expertise personnel makes up the start-up and gives the necessary technical training applied to the user. After the selling, according to lows 2 year warranty starts. All technical service and spare parts requirements can be providing during 10 years with fee.

Other external subjects to warranty are described at start-up, maintenance and installation instruction.

If there is request of technical service for products after their warranty period, pre-discovery, service operations, substitute elements, transportation costs, general costs etc. subjects comes up to a decision after mutual communications. If there is request of periodical maintenance, the frequency of the maintenance, payment conditions, and the sections to be maintained are decided and put into the agreement by the mutual agreement. If those parts to be maintained are not specified in the agreement, the maintenance is done on the points defined by the instruction guide. Periodic maintain madden by technical person can be increase unit's performance.

## **11. HOW TO COME OVER THE TROUBLESHOTS**

During the maintenance activity the electrical connections of the item should be cut off. All power-switches and breakers should be put to OFF site and they should be locked.

### **11.1. How to Find Out the Troubleshoots**

Check these articles below to find out where the problem arises from.

- ✓ Fan return way is right.
- ✓ Pulley axis's are right
- ✓ The belts are not too tight or too relaxed.
- ✓ The belts or the pulleys are not corroded.
- ✓ The air passing surfaces are clean.(wings, body, and fan entrances)
- ✓ The wings and the body are not damaged.
- ✓ The coils, the filters and the ducts are clean.
- ✓ Fan exit connections are designed well.
- ✓ Fan flow suction connections work simultaneously.
- ✓ If they do not work in equal way it forms a misbalanced situation and a force on the rollers which causes the performance to decrease.
- ✓ The air dampers are positioned appropriate with the design conditions.
- ✓ There are no leakages at the item and ducts.

If you still cannot find the reason of the problem, contact with the manufacturer. Try to set ready the information. Below that the manufacturer will need.

- ✓ The location of the item, duct details, the model and the type of the unit.
- ✓ The calculated performance and design values.
- ✓ The system design calculations.
- ✓ The calculated fan performance values, fan static pressure, air-flow, fan speed, absorbed power, outlet temperature.

### **11.2. Table of Finding and Solving Problems**



PROBLEM	SYMPTON	PROBABLE REASON	OTHER REASONS and SOLUTION
Noise	Fan Pallet hits the suction frame	Damaged pallet	Change or correct the pallet
		Damaged suction frame	Change or correct the frame
		Rotor is not centered on the shaft	Center it.
		The shaft is loose on the bearing	Fix it
		Rotor is loose on the shaft.	Squeeze the rotor
	Noise at belt and pulley system	The belts are loose	Adjust the tightness
		The belts are too tight	Adjust the tightness
		Wrong belt cross section	Choose a belt at the right cross section.
		The belts are wearied.	Clean the belts.
		Belts are oily or dirty	Clean the belts
		Belt lengths are different (When the system has more than one belt)	Put on the right belts.
		Pulleys hit the protection	Check the pulleys and the protection.
		The fixing nuts of fan, motor or motor base is loose.	Screw the nuts.
		The pulleys are not on the axis.	Adjust the pulley axis
		Fan shaft is bended	If it is possible repair the shaft otherwise change the shaft
		Motor bearing(s) is damaged	Change the bearings
	Joint of bearing is loose	Tighten the bearing joint	
	Noise from bearings	Shaft-bearing joint is loose	Tighten the shaft-bearing joint
		Fan bearings are wearied or damaged	Change the bearings
		Bearings needs to be greased	Grease the bearings
		Unwanted pieces in the bearing	Clean the bearing
		There may be corrosion on the shaft an bearing wearied or damaged rotor	Clean the corrosion and if there is wear on shaft change the shaft Change the rotor
	High air velocity	Coil face velocity is too high	If the cabinet cross section suits chance the equipment otherwise change the unit
		Fan is to big fort the application	Control the duct dimensions and correct them if fit is necessary
		Ducts too small	
	Noise on the rotor	Too small grills for application	Change the grills
		Default rotor	Change the rotor
		Balance	Adjust the balance
	Vibration	Particulars	Clean the unit or fan
		Vibrating ducts	Fix the ducts , or control the thickness
		Vibrating body parts	Fix the vibrating parts
	ting sound / whistle sound	No vibration isolator or flex joins are used	Use the flex joints and vibration isolator under the vibrating part ( like fan, motor)
Grills, and air damper are filled with un wanted pieces		Clean the pieces	
Leakage from the unit body or ducts.		Seal the body or ducts (Especially joints)	
Small radius elbows		Change the small radius elbows with standard radius elbows	
Sudden reduction or enlargement in the duct cross section		Use the small angle reducers on the ducts.	
HUMIDIFIER	Little humidity	Low water flow	Congestion in the system. Valves closed. There is leakage in pipes.
		Low water level in the water pan	Float valve is default. Water inlet is closed.
		Spray nozzles and/or strainer clogged	Clean the nozzles or strainer
		High air volume	Look at “high air volume” part

PROBLEM	SYMPTON	PROBABLE REASON	OTHER REASONS and SOLUTION	
NO AIR FLOW Motor isn't working	No current at the motor	Electricity is gone	Find the problem and solve it	
		Thermo relay is open	Cables up to motors have errors. Terminal and contactors are weak. Motor Absorbed current too high	
		Control panel error	Find the mistake and correct it.	
		Contact breaker switch is off	Time watch does not work.	
	Motor is working but there isn't air flow.	There is current on the motor	Problem on the motor bearing	Grease or change the bearings
			Wrong connection to terminals	Correct the connections
			Motor Winding problem	Over heating or over load causing burn
	Fan does not work	Rotor–shaft connection or belts are loose	Wrong electricity feeding causing burn	
Fan works	Closed air dampers	Tighten the rotor on shaft and control the belts		
LOW AIR FLOW		Filters are plugged or dirty	Change the filters or clean them	
		The coils are dirty or plugged.	Clean the coils.	
		Rotation direction of fan is wrong. Rotor installation on the wrong direction	Correct the fan rotation direction	
	Belt is slipping	Belts are loose or oily	Tighten the belts or clean the belts	
		System pressure loss is higher than fan design point	Control the pressure losses and change the fan design point	
		Air dampers or grill dampers are closed	Adjust the air dampers or grill dampers	
		There is a mistake in design point or pulley dimensions	Control and change ( if necessary) the fan design point and pulley dimensions	
	Unwanted system leakage on supply side	Access doors open, not enough sealing on ducts or unit body, unwanted open point on ducts.	Control the unit body and duct system and make sealing if it is necessary	
HIGH AIR FLOW		Duct dimensions larger then need , pressure loss lower then calculated or fan pressure	Control the pressure loss calculation , adjust the air damper or decrease the air duct dimensions if it is needed	
	Unwanted system leakage on suction side	Access doors open, not enough sealing on ducts or unit body, unwanted open point on ducts.	Control the unit body and duct system and make sealing if it is necessary.	
		There is a mistake in design point or pulley dimensions	Control and change ( if necessary) the fan design point and pulley dimensions	
	High motor current	Low supply voltage	Motor is over loaded. Measure the current on the motor.	
		Grills are not mounted	Install the grills.	
		Filters are mounted.	Install the filters	
	Filters are clean, first pressure difference is low.	Adjust the air damper using air volume		
HEATING COIL No heating	Boiler is not working	Energy is cut	Thermostat or timer may be out of order. Fuel pipes may be plugged or fuel may be finished	
	No heating fluid in the coil or its temperature is low	Air in the piping system.	Control the piping system for air	
		Pipes or filters may be plugged	Control the system for plugging	
		Automatic valve is closed.	Control thermostat or servomotor, they may be out of order or no energy on servomotor	
	The valves are closed	Open the valves		
HEATING COIL Low heating	heating fluid volume rate is low	Flow setting valves are not open completely. The pipe dimensions are not sufficient. Boiler temperature is low. The coil is plugged	Open the valves completely. Check the pump head and change it if it is necessary. Check the pipe dimensions. If necessary change pipes. Adjust the thermostat. If nothing is changing, control the capacity of boiler. Clean the coil	

<b>PROBLEM</b>	<b>SYMPTON</b>	<b>PROBABLE REASON</b>	<b>OTHER REASONS and SOLUTION</b>
COOLING COIL Low Cooling	Cooling liquid temperature is high.	Cooling capacity is insufficient. In piping system there is excess heat gain.	Control the cooling capacity needed and cooling capacity of chiller. Control the isolation of piping system
	Insufficient cooling liquid flow.	Valves are partially closed or system is plugged.	Open the valve and control the system for plugging
	Cooling coil is partially frozen.	Load is too low	Control the capacity control equipment, If they are okay but un sufficient, close the chillers unit. Control the capacity control equipment of chillers unit
		Low suction temperature	
		Low air volume rate	Control the air flow
		Low inlet air temperature	Control the need for cooling and close the chiller unit if it is not necessary
Un balance air distribution on coil	Control the cooling coil position in the unit.		
COOLING COIL No Cooling	No fluid flow	Un balance air distribution on coil. Automatic valve closed. Manuel valves closed	Control the cooling coil position in the unit. Control the automatic valve. Open the valves
	There is no air-flow		Look at “the air flow”
	There is no water flow		Control the water flow
	Wrong thermostat adjustment	Cooling thermostat setting is too high	Control the thermostat adjustment
	Chiller is not working	No energy on chiller unit. Chiller is out of order	Control the electrical connections of chiller. Repair the chiller unit
STEAM HUMIDIFIER No humidifying	No energy	The energy does not go the elements or to the control valve.	Control the energy supply and thermostatic gear.
	Heating out of order	Safety breakdown switch has problem	Control the switch and change if it is necessary
		No feeding water	Control the valves and main supply
		Low water level in the tank	Control the water level in the tank
	Humidistat adjustment Problem	Wrong adjustment problem	Control and adjust the humidistat in the right way
	No water in the tank	Control the water level of tank and control feeding system	
STEAM HUMIDIFIER Low humidifying	Heater is out of order	Safety breakdown switch has problem	Control the switch and change if it is necessary Control the valves and main supply Control the water level in the tank
		No feeding water	
		Low water level in the tank	
	Steam humidifier and heating elements are filled with dreg.	Water purification s insufficient	Do maintenance or change
	Humidistat adjustment Problem	Wrong adjustment problem	Control and adjust the humidistat in the right way
	Low vapor	Steam holder is out of order.	Control the steam holder
		Hand valves are totally or partially closed.	Control the valves and open them
Low Heating	Heater is fault	Current leakage	Heater connection is separated/Fault cable connection/Low voltage
	Thermostat setting is too low	Thermostat potentiometer is stuck.	Potentiometer cam is fault/fault cable or equipment

## 12. MOTOR INFORMATION

### PERFORMANCE

Speed, Power factor, Efficiency, Moving rotor current  
400 V, 50 Hz Torque values

3 phase, 400 V, 50 Hz  
Service type : S1 (continues)  
Protection level : IP 55 (TEFV)  
Isolation class : F (105K)  
Temp. Increase : Class B (80K)

Power Out	TYPE	Full Load Data										Inertia moment J	Weight B3	Appropriate cable cross section for NY Y mm <sup>2</sup>
		Speed n min <sup>-1</sup>	Current I <sub>N</sub> A			Torque M <sub>N</sub> Nm	Power factor Cos Ø	Efficiency η %						
At 380V	At 400V		At 415V	At 4/4	At 3/4			Kg/m <sup>2</sup>	kg					

2 kutup, 3000 min<sup>-1</sup>

0.09	AGM	56	2a	2800	0.26	0.26	0.29	0.31	0.74	65.3	65.0	0.00011	2.7	
0.12	AGM	56	2b	2800	0.39	0.35	0.37	0.41	0.72	66.4	66.0	0.00012	2.9	
0.18	AGM	63	2a	2820	0.50	0.49	0.50	0.61	0.80	66.3	66.0	0.00011	3.3	
0.25	AGM	63	2b	2840	0.65	0.66	0.61	0.85	0.79	69.2	69.0	0.00013	3.7	4*2.5
0.37	AGM	71	2a	2800	1.10	1.05	1.02	1.26	0.73	67.8	67.5	0.00026	5.1	4*2.5
0.55	AGM	71	2b	2780	1.30	1.27	1.25	1.90	0.84	73.5	73.2	0.00034	6.3	4*2.5
0.75	AGM	80	2a	2780	1.80	1.90	1.80	2.60	0.83	71.6	71.3	0.00053	7.8	4*2.5
1.1	AGM	80	2b	2800	2.45	2.50	2.35	3.80	0.83	78.1	78.0	0.00066	8.9	4*2.5
1.5	AGM	90	S2	2800	3.45	3.30	3.30	5.10	0.84	79.2	79.0	0.0011	11.4	4*2.5
2.2	AGM	90	L2	2840	4.90	4.65	4.60	7.40	0.84	81.6	81.5	0.0014	13.8	4*2.5
3	C.AGM	90	L2	2840	6.50	6.20	6	10	0.84	83.7	83.6	0.0017	16	4*2.5
3	AGM	100	L2	2850	6.60	6.10	6	10	0.87	83.2	83.1	0.0024	17.3	4*2.5
4	C.AGM	100	L2	2870	8.20	8	7.60	13.3	0.85	84.8	84.7	0.0031	21	4*2.5
4	AGM	112	M2	2850	8.20	7.80	7.70	13.4	0.87	84.8	84.8	0.0039	27	4*2.5
5.5	C.AGM	112	M2	2870	11	10.8	10.6	18.3	0.86	86.1	86.0	0.0048	30	4*2.5
5.5	AGM	132	S 2a	2870	11.3	11	10.8	18.4	0.84	85.9	85.8	0.0090	33	4*2.5
7.5	AGM	132	S 2b	2890	15.4	14.7	14.3	24.8	0.85	87.6	87.5	0.012	39	4*4
11	C.AGM	132	M2	2915	22	21.5	21	36	0.84	89.2	89.1	0.018	59	4*6
11	GM	160	M2a	2935	22.4	21.5	21	36	0.84	88.5	88.5	0.026	96	4*6
15	GM	160	M2b	2940	28.5	28	27	49	0.86	89.5	89.5	0.034	107	4*6
18.5	GM	160	L2	2940	35	34	33	60.4	0.87	90.5	90.5	0.041	122	4*10
22	C. GM	160	L2	2930	41	39	38	71.7	0.88	91.3	91.3	0.051	140	4*10
22	GM	180	M2	2950	41.5	40	39	71.5	0.88	91.0	91.0	0.064	164	4*10
30	C. GM	180	L2	2940	56	54	52	97	0.88	92.2	92.2	0.082	190	4*16
30	GM	200	L2a	2940	56	54	52	97	0.88	91.8	91.7	0.10	220	4*16
37	GM	200	L2b	2955	68	65	63	120	0.89	92.5	92.5	0.13	240	3*25+16
45	C. GM	200	L2	2960	82	78	76	145	0.90	93.0	93.0	0.15	275	3*35+16
45	GM	225	M2	2960	82	78	76	145	0.90	93.0	93.0	0.19	315	3*35+16
55	C. GM	225	M2	2965	100	95	92	177	0.90	93.3	93.2	0.23	343	3*50+25
55	GM	250	M2	2970	100	95	92	177	0.90	93.2	93.3	0.32	390	3*50+25
75	C. GM	250	M2	2970	134	128	123	241	0.90	93.9	93.9	0.41	450	3*70+35
75	GM	280	S2	2975	136	129	125	241	0.90	93.8	93.8	0.50	540	3*70+35
90	GM	280	M2	2970	161	152	148	289	0.91	94.0	94.0	0.62	590	3*95+50
110	C. GM	280	M2	2975	196	186	180	353	0.91	94.0	94.0	0.74	640	3*120+70
110	GM	315	S2	2980	196	186	180	353	0.91	93.8	93.8	1.3	787	3*120+70
132	GM	315	M2a	2980	235	223	216	423	0.91	93.9	93.9	1.5	895	0
160	GM	315	M2b	2980	280	266	258	513	0.92	94.4	94.4	2.0	1020	3*120+70
185	GM	315	L2a	2900	320	304	295	593	0.93	94.5	94.4	2.2	1120	0
200	GM	315	L2b	2900	341	330	320	641	0.93	94.5	94.4	2.3	1150	0
250	GM	355	M2a	2980	438	416	401	801	0.91	95.0	95.0	2.8	1310	
315	GM	355	M2b	2975	545	518	499	1011	0.92	95.0	95.0	3.6	1460	
355	GM	355	M2c	2980	610	580	563	1138	0.93	95.0	95.0	4.2	1620	
400	GM	355	L2	2980	690	656	632	1282	0.92	95.1	95.0	4.7	1850	

## PERFORMANCE

Speed, Power factor, Efficiency, Moving rotor current  
400 V, 50 Hz Torque values

3 phase, 400 V, 50 Hz  
Service type : S1 (continues)  
Protection level : IP 55 (TEFV)  
Isolation class : F (105K)  
Temp. Increase : Class B (80K)

Power Out Kw	TYPE			Full Load Data								Inertia moment J	Weight B3 kg	Appropriate cable cross section for NYY mm <sup>2</sup>
				Speed n min <sup>-1</sup>	Current I <sub>N</sub> A			Torque M <sub>N</sub> Nm	Power factor Cos Ø	Efficiency η %				
					At 380V	At 400V	At 415V			At 4/4	At 3/4	Kg/m <sup>2</sup>		
0.06	AGM	56	4a	1370	0.24	0.25	0.27	0.42	0.56	58.7	58.6	0.000	2.7	
0.09	AGM	56	4b	1375	0.35	0.36	0.38	0.63	0.54	64.4	64.2	0.000	2.8	
0.12	AGM	63	4a	1365	0.40	0.41	0.42	0.84	0.65	58.8	58.8	0.000	3.2	
0.18	AGM	63	4b	1340	0.58	0.60	0.60	1.28	0.65	61.4	61.4	0.000	3.7	
0.25	AGM	71	4a	1380	0.81	0.81	0.82	1.73	0.68	63.6	63.5	0.000	4.9	4*2.5
0.37	AGM	71	4b	1390	1.20	1.15	1.15	2.54	0.69	70.0	70.0	0.000	5.9	4*2.5
0.55	AGM	80	4a	1365	1.60	1.60	1.55	3.90	0.71	70.9	70.8	0.000	7.6	4*2.5
0.75	AGM	80	4b	1370	2.10	2.00	2.00	5.20	0.74	72.2	72.2	0.001	8.7	4*2.5
1.1	AGM	90	S4	1380	2.70	2.60	2.55	7.60	0.79	76.8	76.7	0.001	11.5	4*2.5
1.5	AGM	90	L4	1390	3.60	3.50	3.40	10.3	0.78	78.6	78.5	0.002	13.6	4*2.5
2.2	AGM	100	L4a	1400	5.30	5.10	5.20	15	0.77	81.3	81.2	0.004	17.3	4*2.5
3	AGM	100	L4b	1405	6.60	6.45	6.35	20.4	0.81	82.9	82.9	0.005	20.8	4*2.5
4	AGM	112	M4	1420	8.70	8.20	8.20	27	0.82	84.7	84.7	0.009	28.7	4*2.5
5.5	AGM	132	S4	1430	11.8	11.3	11	36.7	0.82	86.2	86.2	0.019	39	4*2.5
7.5	AGM	132	M4	1430	15.8	15.3	15	50	0.80	87.4	87.2	0.026	47	4*4
9	C.AGM	132	M4	1445	19	18	17.5	59.5	0.82	88.4	88.0	0.032	56	4*4
11	GM	160	M4	1455	22.5	21.5	21	72.2	0.84	88.6	88.5	0.054	108	4*6
15	GM	160	L4	1460	30.5	29	28.5	98	0.83	89.5	89.5	0.072	140	4*6
18.5	C. GM	160	L4	1450	37	35	34.5	122	0.83	90.1	90.1	0.084	150	4*10
18.5	GM	180	M4	1460	38	36	35	121	0.82	90.1	90.1	0.11	160	4*10
22	GM	180	L4	1460	44	42	40.5	144	0.83	90.7	90.7	0.13	185	4*10
30	GM	200	L4	1460	57	54	52	196	0.88	91.5	91.5	0.19	240	4*16
37	C. GM	200	L4	1465	69	66	64	241	0.88	92.1	92.1	0.23	260	3*25+16
37	GM	225	S4	1465	70	66	64	241	0.87	92.2	92.2	0.29	275	3*25+16
45	GM	225	M4	1465	84	80	77	293	0.87	92.7	92.7	0.35	320	3*35+16
55	C. GM	225	M4	1470	101	96	93	357	0.88	93.2	93.2	0.44	360	3*50+25
55	GM	250	M4	1470	102	97	94	357	0.88	93.0	93.0	0.54	400	3*50+25
75	C. GM	250	M4	1470	138	131	127	487	0.87	93.3	93.6	0.72	455	3*70+35
75	GM	280	S4	1475	140	133	128	485	0.87	93.6	93.6	0.90	530	3*70+35
90	GM	280	M4	1480	166	158	152	581	0.88	93.9	93.9	1.1	610	3*95+50
110	C. GM	280	M4	1480	204	194	183	710	0.87	94.0	94.0	1.3	660	3*120+70
110	GM	315	S4	1480	205	195	189	710	0.87	94.0	94.0	1.9	770	3*120+70
132	GM	315	M4a	1485	245	233	225	849	0.87	94.0	94.0	2.4	890	3*120+70
160	GM	315	M4b	1485	295	280	272	1029	0.88	94.3	94.2	3.1	1015	
185	GM	315	L4a	1485	340	323	312	1190	0.88	94.4	94.3	3.6	1115	
200	GM	315	L4b	1485	368	350	339	1286	0.87	94.4	94.3	3.9	1165	
250	GM	355	M4a	1485	450	428	415	1608	0.88	95.8	95.8	6.5	1450	
315	GM	355	M4b	1485	560	532	515	2026	0.89	96.2	96.2	8.1	1657	
355	GM	355	M4c	1485	635	603	582	2283	0.88	96.3	96.3	9.4	1800	
400	GM	355	L4	1485	710	675	650	2572	0.89	96.3	96.3	10	1965	

PERFORMANCE

3 phase, 400 V, 50 Hz  
 Service type : S1 (continues)  
 Protection level : IP 55 (TEFV)  
 Isolation class : F (105K)  
 Temp. Increase : Class B (80K)

Speed, Power factor, Efficiency, Moving rotor current  
 400 V,50 Hz Torque values

Power Out	TYPE	Full Load Data								Inertia moment J	Weight B3	Appropriate cable cross section for NY Y mm <sup>2</sup>
		Speed n min <sup>-1</sup>	Current I <sub>N</sub> A			Torque M <sub>N</sub> At 4/4	Power factor Cos Ø	Efficiency η %				
At 380V	At 400V		At 415V	At 4/4	At 4/4			At 4/4	Kg/m <sup>2</sup>	kg		

6 Kutup, 1000 min<sup>-1</sup>

0.18	AGM	71	6a	920	0.60	0.61	0.62	1.87	0.64	67.0	0.00064	5.4	
0.25	AGM	71	6b	910	0.83	0.83	0.85	2.62	0.66	65.3	0.00086	6.3	4*2.5
0.37	AGM	80	6a	910	1.10	1.10	1.10	3.90	0.65	74.9	0.0017	8.1	4*2.5
0.55	AGM	80	6b	890	1.50	1.50	1.50	5.90	0.73	72.3	0.0022	9.5	4*2.5
0.75	AGM	90	S6	910	2.20	2.10	2.10	7.90	0.70	74.0	0.0029	11.4	4*2.5
1.1	AGM	90	L6	915	3.10	3.00	3.00	11.5	0.69	76.8	0.0038	13.7	4*2.5
1.5	AGM	100	L6	925	3.60	3.50	3.60	15.5	0.77	76.9	0.0084	19.4	4*2.5
2.2	AGM	112	M6	940	5.30	5.10	5.00	22.4	0.75	82.6	0.013	26.5	4*2.5
3	AGM	132	S6	945	7.00	6.90	6.80	30.5	0.76	82.6	0.022	36	4*2.5
4	AGM	132	M6a	940	9.40	9.00	8.80	41	0.78	82.6	0.028	43.5	4*2.5
5.5	AGM	132	M6b	945	13	12.3	12	55.6	0.76	84.4	0.043	49.6	4*2.5
7.5	GM	160	M6	960	16	15.2	14.3	74.6	0.82	87.1	0.079	115	4*4
11	GM	160	L6	955	23	22	21.5	110	0.83	86.6	0.11	131	4*6
15	GM	180	L6	960	30.5	29	28	149	0.83	89.7	0.16	187	4*6
18.5	GM	200	L6a	970	38	36	35	182	0.83	89.6	0.21	216	4*10
22	GM	200	L6b	975	45	43	41	216	0.82	90.5	0.26	240	4*10
30	GM	225	M6	970	61	58	56	294	0.82	91.0	0.57	330	4*16
37	C. GM	225	M6	980	75	71	69	363	0.82	91.6	0.71	365	3*25+16
37	GM	250	M6	970	75	71	69	364	0.82	91.6	0.77	400	3*25+16
45	C. GM	250	M6	975	90	88	83	441	0.82	91.8	0.99	450	3*35+16
45	GM	280	S6	980	93	90	85	439	0.80	91.8	1.2	530	3*35+16
55	GM	280	M6	985	113	107	104	533	0.80	92.7	1.5	605	3*50+25
75	C. GM	280	M6	985	150	143	138	727	0.81	93.3	1.6	700	3*70+35
75	GM	315	S6	985	146	139	134	727	0.83	93.3	3.3	740	3*70+35
90	GM	315	M6a	985	175	166	161	873	0.85	92.5	4.1	850	3*95+50
110	GM	315	M6b	990	208	198	191	1061	0.85	94.5	5.4	975	3*120+70
132	GM	315	L6	990	247	235	227	1273	0.86	94.2	6.4	1040	3*120+70
160	GM	355	M6a	990	305	290	281	1543	0.84	94.6	7.1	1350	
200	GM	355	M6b	990	380	361	350	1929	0.85	94.4	8.9	1540	
250	GM	355	M6c	990	474	450	431	2388	0.85	94.5	11	1720	
315	GM	355	L6	990	600	570	550	3039	0.84	94.5	13	2100	

### 13. DIMENSIONS OF AIR HANDLING UNIT

#### PK-25 SERIES AHU (UKS 10 / UKS 65)

MODEL		UKS 10	UKS 15	UKS 20	UKS 25	UKS 30	UKS 35	UKS 40	UKS 45	UKS 50	UKS 55	UKS 60	UKS 65	
SECTION	HEIGHT (H)	650	715	740	775	840	970	1030	1095	1225	1290	1415	1415	
	WIDTH (W)	775	910	1060	1125	1250	1320	1445	1670	1850	2120	2120	2320	
AIR DAMPER	WIDTH (W)*	675	810	960	1025	1150	1220	1345	1570	1750	2020	2020	2220	
	WIDTH (W)**	520	655	805	870	995	1065	1190	1415	1595	1865	1865	2065	
	HEIGHT (H)	185	185	272	272	272	360	360	360	447	447	535	535	
	Fresh air unit	405	405	405	405	405	405	405	395	465	465	545	545	
	Ventilator ve Aspirator	860	960	960	1025	1140	1240	1340	1440	1540	1690	1790	1840	
	Heating Coil	310	310	310	310	310	310	310	310	310	310	310	310	
	Cooling coil	565	565	565	565	565	565	565	565	565	565	565	565	
	Electrical heater	310	310	310	310	310	310	310	310	310	310	310	310	
	Steam humidifier	740	740	740	740	740	740	740	840	840	840	840	840	
	Air washer	1588	1588	1588	1588	1588	1588	1588	1588	1588	1588	1588	1588	
	Plate type HR	1050	1170	1170	1320	1460	1600	1600	1600	1880	1880	2170	2170	
	Rotary type HR	530	530	530	530	530	530	570	570	570	570	570	570	
	Run around coil	565	565	565	565	565	565	565	565	565	565	565	565	
	Raw filter	45	45	45	45	45	45	45	45	45	45	45	45	
	Bag or combine filter	250 mm	830	830	830	830	830	830	830	830	830	830	830	830
		380 mm	830	830	830	830	830	830	830	830	830	830	830	830
		460 mm	970	970	970	970	970	970	970	970	970	970	970	970
		560 mm	1070	1070	1070	1070	1070	1070	1070	1070	1070	1070	1070	1070
		765 mm	1270	1270	1270	1270	1270	1270	1270	1270	1270	1270	1270	1270
	Minipleated (Rigid) or Combine Filter	830	830	830	830	830	830	830	830	830	830	830	830	
	Carbon filter	Panel	485	485	485	485	485	485	485	485	485	485	485	
		Active 430	950	950	950	950	950	950	950	950	950	950	950	
		Active 700	1220	1220	1220	1220	1220	1220	1220	1220	1220	1220	1220	
	Silencer	500 mm	840	840	840	840	840	840	880	880	880	880	880	
		750 mm	1090	1090	1090	1090	1090	1090	1090	1130	1130	1130	1130	
		1100 mm	1440	1440	1440	1440	1440	1440	1440	1480	1480	1480	1480	
		1400 mm	1790	1790	1790	1790	1790	1790	1790	1830	1830	1830	1830	
	Egzost and mixing unit	396	396	440	440	440	484	484	479	557	557	641	641	

(\*) fresh air damper dimension in 100% fresh air AHU and return air damper dimension in mixed AHU.

(\*\*) fresh air and exhaust air damper dimension in mixed AHU.



**PK-25 SERIES AHU (UKS 70 / UKS 120)**

















MODEL		UKS 70	UKS 75	UKS 80	UKS 85	UKS 90	UKS 95	UKS 100	UKS 105	UKS 110	UKS 115	UKS 120	
SECTION	HEIGHT (H)	1540	1540	1670	1670	1805	1865	2050	2120	2370	2630	2880	
	WIDTH (W)	2320	2610	2610	2865	2865	3160	3160	3450	3450	3450	3450	
AIR DAMPER	WIDTH (W)*	2220	2510	2510	2765	2765	3060	3060	3350	3350	3350	3350	
	WIDTH (W)**	2065	2355	2355	2610	2610	2905	2905	3195	3195	3195	3195	
	HEIGHT (H)	622	622	622	622	710	710	797	797	885	972	972	
	Fresh air unit	645	645	645	645	725	725	815	815	905	995	995	
	Ventilator ve Aspirator	1840	1890	2005	2005	2170	2170	2440	2640	2640	2690	2690	
	Heating Coil	310	310	310	310	310	310	310	310	310	310	310	
	Cooling coil	565	565	565	565	565	565	565	565	565	565	565	
	Electrical heater	310	310	310	310	310	310	310	310	310	310	310	
	Steam humidifier	840	840	840	840	840	840	1040	1040	1040	1240	1240	
	Air washer	1588	1588	1588	1588	1588	1588	1588	1588	1588	1588	1588	
	Plate type HR	2740	2740	2740	3300	3300	3870	3870	3870	3870	3870	3870	
	Rotary type HR	570	680	680	680	680	790	790	790	790	790	790	
	Run around coil	565	565	565	565	565	565	565	565	565	565	565	
	Raw filter	45	45	45	45	45	45	45	45	45	45	45	
	Bag or combine filter	250 mm	830	830	830	830	830	830	830	830	830	830	830
		380 mm	830	830	830	830	830	830	830	830	830	830	830
		460 mm	970	970	970	970	970	970	970	970	970	970	970
		560 mm	1070	1070	1070	1070	1070	1070	1070	1070	1070	1070	1070
		765 mm	1270	1270	1270	1270	1270	1270	1270	1270	1270	1270	1270
		915 mm	1420	1420	1420	1420	1420	1420	1420	1420	1420	1420	1420
	Minipleated (Rigid) or Combine Filter	820	830	830	830	830	830	830	830	830	830	830	
	Carbon filter	Panel	485	485	485	485	485	485	485	485	485	485	485
		Active 430	950	950	950	950	950	950	950	950	950	950	950
		Active 700	1220	1220	1220	1220	1220	1220	1220	1220	1220	1220	1220
	Silencer	500 mm	880	880	880	1040	1040	1040	1040	1040	1040	1040	
		750 mm	1130	1130	1130	1290	1290	1290	1290	1290	1290	1290	
		1100 mm	1480	1480	1480	1640	1640	1640	1640	1640	1640	1640	
		1400 mm	1830	1830	1830	1990	1990	1990	1990	1990	1990	1990	
	Egzost and mixing unit	735	735	735	735	819	819	907	907	996	1085	1085	

(\*) fresh air damper dimension in 100% fresh air AHU and return air damper dimension in mixed AHU.



(\*\*) fresh air and exhaust air damper dimension in mixed AHU.

**PK-50 STANDARD AND PKH-50 HYGIENIC SERIES AHU (UKS 10 / UKS 65)**

MODEL		UKS 10	UKS 15	UKS 20	UKS 25	UKS 30	UKS 35	UKS 40	UKS 45	UKS 50	UKS 55	UKS 60	UKS 65
SECTION	HEIGHT (H)	660	725	750	785	850	980	1040	1105	1235	1300	1425	1425
	WIDTH (W)	815	950	1100	1165	1290	1360	1485	1710	1890	2160	2160	2360
AIR DAMPER	WIDTH (W)*	715	850	1000	1065	1190	1260	1385	1610	1790	2060	2060	2260
	WIDTH (W)**	555	690	840	905	1030	1100	1235	1450	1630	1900	1900	2100
	HEIGHT (H)	185	185	272	272	272	360	360	360	447	447	535	535
	Fresh air unit	395	395	395	395	395	395	395	395	465	465	545	545
	Ventilator ve Aspirator	870	970	970	1035	1150	1250	1350	1450	1550	1700	1800	1850
	Heating Coil	310	310	310	310	310	310	310	310	310	310	310	310
	Cooling coil	565	565	565	565	565	565	565	565	565	565	565	565
	Electrical heater	310	310	310	310	310	310	310	310	310	310	310	310
	Steam humidifier	740	740	740	740	740	740	740	840	840	840	840	840
	Air washer	1725	1725	1725	1725	1725	1725	1725	1725	1725	1725	1725	1725
	Plate type HR	1040	1180	1180	1330	1470	1610	1610	1610	1890	1890	2180	2180
	Rotary type HR	540	540	540	540	540	540	580	580	580	580	580	580
	Run around coil	565	565	565	565	565	565	565	565	565	565	565	565
	Raw filter	45	45	45	45	45	45	45	45	45	45	45	45
	Bag or combine filter	250 mm	840	840	840	840	840	840	840	840	840	840	840
		380 mm	860	860	860	860	860	860	860	860	860	860	860
		460 mm	980	980	980	980	980	980	980	980	980	980	980
		560 mm	1080	1080	1080	1080	1080	1080	1080	1080	1080	1080	1080
		765 mm	1280	1280	1280	1280	1280	1280	1280	1280	1280	1280	1280
		915 mm	1430	1430	1430	1430	1430	1430	1430	1430	1430	1430	1430
	Minipleated (Rigid) or Combine Filter	840	840	840	840	840	840	840	840	840	840	840	840
	Carbon filter	Panel	485	485	485	485	485	485	485	485	485	485	485
		Active 430	950	950	950	950	950	950	950	950	950	950	950
		Active 700	1220	1220	1220	1220	1220	1220	1220	1220	1220	1220	1220
	Silencer	500 mm	840	840	840	840	840	840	880	880	880	880	880
		750 mm	1090	1090	1090	1090	1090	1090	1090	1130	1130	1130	1130
		1100 mm	1440	1440	1440	1440	1440	1440	1440	1480	1480	1480	1480
		1400 mm	1790	1790	1790	1790	1790	1790	1790	1830	1830	1830	1830
	Egzost and mixing unit	397	397	441	441	441	485	485	485	563	563	647	647

(\*) fresh air damper dimension in 100% fresh air AHU and return air damper dimension in mixed AHU.

(\*\*) fresh air and exhaust air damper dimension in mixed AHU.

















**PK-50 STANDARD AND PKH-50 HYGIENIC SERIES AHU (UKS 70 / UKS 120)**

MODEL		UKS 70	UKS 75	UKS 80	UKS 85	UKS 90	UKS 95	UKS 100	UKS 105	UKS 110	UKS 115	UKS 120
SECTION	HEIGHT (H)	1550	1550	1680	1680	1815	1875	2060	2130	2380	2640	2890
	WIDTH (W)	2360	2650	2650	2905	2905	3200	3200	3500	3500	3500	3500
AIR DAMPER	WIDTH (W)*	2260	2550	2550	2805	2805	3100	3100	3400	3400	3400	3400
	WIDTH (W)**	2100	2390	2390	2645	2645	2940	2940	3230	3230	3230	3230
	HEIGHT (H)	622	622	622	622	710	710	797	797	885	972	972
	Fresh air unit	645	645	645	645	725	725	815	815	905	995	995
	Ventilator ve Aspirator	1850	1900	2015	2015	2180	2180	2450	2650	2650	2700	2700
	Heating Coil	310	310	310	310	310	310	310	310	310	310	310
	Cooling coil	565	565	565	565	565	565	565	565	565	565	565
	Electrical heater	310	310	310	310	310	310	310	310	310	310	310
	Steam humidifier	840	840	840	840	840	840	1040	1040	1040	1240	1240
	Air washer	1725	1725	1725	1725	1725	1725	1725	1725	1725	1725	1725
	Plate type HR	2750	2750	2750	3310	3310	3880	3880	3880	3880	3880	3880
	Rotary type HR	580	690	690	690	690	800	800	800	800	800	800
	Run around coil	565	565	565	565	565	565	565	565	565	565	565
	Raw filter	45	45	45	45	45	45	45	45	45	45	45
	Bag or combine filter	250 mm	840	840	840	840	840	840	840	840	840	840
		380 mm	840	840	840	840	840	840	840	840	840	840
		460 mm	980	980	980	980	980	980	980	980	980	980
		560 mm	1080	1080	1080	1080	1080	1080	1080	1080	1080	1080
		765 mm	1280	1280	1280	1280	1280	1280	1280	1280	1280	1280
		915 mm	1430	1430	1430	1430	1430	1430	1430	1430	1430	1430
	Minipleated (Rigid) or Combine Filter	840	840	840	840	840	840	840	840	840	840	840
	Carbon filter	Panel	485	485	485	485	485	485	485	485	485	485
		Active 430	950	950	950	950	950	950	950	950	950	950
		Active 700	1220	1220	1220	1220	1220	1220	1220	1220	1220	1220
	Silencer	500 mm	880	880	880	1040	1040	1040	1040	1040	1040	1040
		750 mm	1130	1130	1130	1290	1290	1290	1290	1290	1290	1290
		1100 mm	1480	1480	1480	1640	1640	1640	1640	1640	1640	1640
		1400 mm	1830	1830	1830	1990	1990	1990	1990	1990	1990	1990
	Egzost and mixing unit	880	880	880	880	880	880	880	880	880	880	880

(\*) fresh air damper dimension in 100% fresh air AHU and return air damper dimension in mixed AHU.

(\*\*) fresh air and exhaust air damper dimension in mixed AHU.

**PKC-60 SERIES AHU (UKS 10 / UKS 65)**

MODEL		UKS 10	UKS 15	UKS 20	UKS 25	UKS 30	UKS 35	UKS 40	UKS 45	UKS 50	UKS 55	UKS 60	UKS 65
SECTION	HEIGHT (H)	690	755	780	815	880	1010	1070	1135	1265	1330	1455	1455
	WIDTH (W)	845	980	1130	1195	1320	1390	1515	1740	1920	2190	2190	2390
AIR DAMPER	WIDTH (W)*	675	810	960	1025	1150	1220	1345	1570	1750	2020	2020	2220
	WIDTH (W)**	520	655	805	870	995	1065	1190	1415	1595	1865	1865	2065
	HEIGHT (H)	185	185	272	272	272	360	360	360	447	447	535	535
	Fresh air unit	405	405	405	405	405	405	405	395	465	465	545	545
	Ventilator ve Aspirator	860	960	960	1025	1140	1240	1340	1440	1540	1690	1790	1840
	Heating Coil	310	310	310	310	310	310	310	310	310	310	310	310
	Cooling coil	565	565	565	565	565	565	565	565	565	565	565	565
	Electrical heater	310	310	310	310	310	310	310	310	310	310	310	310
	Steam humidifier	740	740	740	740	740	740	740	840	840	840	840	840
	Air washer	1610	1610	1610	1610	1610	1610	1610	1610	1610	1610	1610	1610
	Plate type HR	1050	1170	1170	1320	1460	1600	1600	1600	1880	1880	2170	2170
	Rotary type HR	530	530	530	530	530	530	570	570	570	570	570	570
	Run around coil	565	565	565	565	565	565	565	565	565	565	565	565
	Raw filter	45	45	45	45	45	45	45	45	45	45	45	45
	Bag or combine filter	250 mm	830	830	830	830	830	830	830	830	830	830	830
		380 mm	830	830	830	830	830	830	830	830	830	830	830
		460 mm	970	970	970	970	970	970	970	970	970	970	970
		560 mm	1070	1070	1070	1070	1070	1070	1070	1070	1070	1070	1070
		765 mm	1270	1270	1270	1270	1270	1270	1270	1270	1270	1270	1270
		915 mm	1420	1420	1420	1420	1420	1420	1420	1420	1420	1420	1420
	Minipleated (Rigid) or Combine Filter	830	830	830	830	830	830	830	830	830	830	830	830
	Carbon filter	Panel	485	485	485	485	485	485	485	485	485	485	485
		Active 430	950	950	950	950	950	950	950	950	950	950	950
		Active 700	1220	1220	1220	1220	1220	1220	1220	1220	1220	1220	1220
	Silencer	500 mm	840	840	840	840	840	840	840	840	840	840	840
		750 mm	1090	1090	1090	1090	1090	1090	1090	1090	1090	1090	
		1100 mm	1440	1440	1440	1440	1440	1440	1440	1440	1440	1440	
		1400 mm	1790	1790	1790	1790	1790	1790	1790	1790	1790	1790	
	Egzost and mixing unit	396	396	440	440	440	484	484	479	557	557	641	641

(\*) fresh air damper dimension in 100% fresh air AHU and return air damper dimension in mixed AHU.

(\*\*) fresh air and exhaust air damper dimension in mixed AHU.

**PKC-60 SERIES AHU (UKS 70 / UKS 120)**

MODEL		UKS 70	UKS 75	UKS 80	UKS 85	UKS 90	UKS 95	UKS 100	UKS 105	UKS 110	UKS 115	UKS 120
SECTION	HEIGHT (H)	1580	1580	1710	1710	1845	1905	2090	2160	2410	2670	2920
	WIDTH (W)	2390	2680	2680	2935	2935	3230	3230	3530	3530	3530	3530
AIR DAMPER	WIDTH (W)*	2260	2550	2550	2805	2805	3100	3100	3400	3400	3400	3400
	WIDTH (W)**	2100	2390	2390	2645	2645	2940	2940	3240	3240	3240	3240
	HEIGHT (H)	622	622	622	622	710	710	797	797	885	972	972
	Fresh air unit	645	645	645	645	725	725	815	815	905	995	995
	Ventilator ve Aspirator	1850	1900	2015	2015	2180	2180	2450	2650	2650	2700	2700
	Heating Coil	310	310	310	310	310	310	310	310	310	310	310
	Cooling coil	565	565	565	565	565	565	565	565	565	565	565
	Electrical heater	310	310	310	310	310	310	310	310	310	310	310
	Steam humidifier	840	840	840	840	840	840	1040	1040	1040	1240	1240
	Air washer	1610	1610	1610	1610	1610	1610	1610	1610	1610	1610	1610
	Plate type HR	2760	2760	2760	3320	3320	3890	3890	3890	3890	3890	3890
	Rotary type HR	590	700	700	700	700	810	810	810	810	810	810
	Run around coil	565	565	565	565	565	565	565	565	565	565	565
	Raw filter	45	45	45	45	45	45	45	45	45	45	45
	Bag or combine filter	250 mm	840	840	840	840	840	840	840	840	840	840
		380 mm	840	840	840	840	840	840	840	840	840	840
		460 mm	980	980	980	980	980	980	980	980	980	980
		560 mm	1080	1080	1080	1080	1080	1080	1080	1080	1080	1080
		765 mm	1280	1280	1280	1280	1280	1280	1280	1280	1280	1280
		915 mm	1430	1430	1430	1430	1430	1430	1430	1430	1430	1430
	Minipleated (Rigid) or Combine Filter	840	840	840	840	840	840	840	840	840	840	840
	Carbon filter	Panel	485	485	485	485	485	485	485	485	485	485
		Active 430	950	950	950	950	950	950	950	950	950	950
		Active 700	1220	1220	1220	1220	1220	1220	1220	1220	1220	1220
	Silencer	500 mm	880	880	880	1040	1040	1040	1040	1040	1040	1040
		750 mm	1130	1130	1130	1290	1290	1290	1290	1290	1290	1290
		1100 mm	1480	1480	1480	1640	1640	1640	1640	1640	1640	1640
		1400 mm	1830	1830	1830	1990	1990	1990	1990	1990	1990	1990
	Egzost and mixing unit	746	746	746	746	830	830	918	918	1007	1096	1096

(\*) fresh air damper dimension in 100% fresh air AHU and return air damper dimension in mixed AHU.



(\*\*) fresh air and exhaust air damper dimension in mixed AHU.

This warranty given by ÜNTES is out of scope, if the unit is used out of its purpose and the following cases come happen:

1. Damage and failures resulting from incorrect use.
2. Damages and failures while loading, unloading and transporting after delivery of the production.
3. Damage and failures resulting from low or high voltage; faulty electrical wiring; using different voltage from written value in the product label or user manual.
4. Failures and damage caused by lightning, fire and future.
5. Failures resulting from using contrary to the user manual.
6. Failures resulting from interference to the defective product by other than authorized service personnel.

The mentioned defects can be repaired by charging the cost to you and product warranty starts from date of invoice.

## **CONTACT INFORMATION FOR SERVICE and SPARE PARTS**

### *Head Office & Factory*

İstanbul Yolu 37. Km Kazan – ANKARA/TURKEY  
Phone: +90(312) 818 63 00 (pbx) - Fax: +90(312) 818 61 50

### *Sales & Ankara District*

53. Cadde 1450. Sokak Ulusoy Plaza No:9 / 50 Çukurambar - ANKARA/TURKEY  
Phone: +90(312) 287 91 00 (pbx) - Fax: +90(312) 284 91 00

### *İstanbul District*

Atatürk Mah. Bulvar S. No:11 Untes İş Merkezi Küçükbakkalköy Ataşehir - İSTANBUL/TURKEY  
Phone: +90(216) 456 04 10 (pbx) - Fax: +90(216) 455 12 90

### *İzmir District*

Teknik Malzeme İş Merkezi 1348 Sok. No:5 Kat:2 D:223 Gıda Çarşısı Yenışehir - İZMİR/TURKEY  
Phone: +90(232) 469 05 55 (pbx) - Fax: +90(232) 459 12 92

### *Adana District*

Fuzuli Caddesi Galeria İş Merkezi 2.Kat No:250 ADANA/TURKEY  
Phone: +90(322) 459 00 40 (pbx) - Fax: +90(322) 459 01 80

**www.unt.es.com.tr**

**unt.es@unt.es.com.tr**



# UNTES®

## HEATING VENTILATING AIR CONDITIONING

### ATTENTION!

BE SURE THAT, THE MARKED EQUIPMENTS IN THE LIST OF MATERIALS ARE REACHED YOU WITH SHIPMENT. OTHERWISE, INFORM US AS SOON AS POSSIBLE.

	QUANTITY	STATUS
USER MANUEL		
FITTINGS		
SEALING GASKET		
METAL FILTER		
RAW FILTER		
BAG FILTER		
MINIPLEATED FILTER		
CARBON FILTER		
SIPHON		
OTHER		
ORDER NUMBER		
PRODUCTION ORDER NUMBER		
NOTE		